



COMPANY PROFILE

SORL Auto Parts, Inc. located in Ruian, Zhejiang Province, a coastal city by East China Sea, is a major manufacturer of spare parts for all commercial vehicles brands. With a registered capital of 53,788,900 US Dollar and about 4000 employees working in a Plant of 270,000 m², SORL was successfully listed on the main-board of NASDAQ global market in 2006.

The company supplies air brake systems and relative components to more than 70 OEM customers in China, such as FAW and DongFeng, and were awarded several times as Excellent Supplier. Moreover, it has 7 sales branches and established relations with hundreds of distributors all around the world, as well as a distribution network with 27 authorized distributors and 800 sub-distributors all over China.

Decades of effort makes SORL the biggest Manufacturing Base of Air Brake Valves in China, China Top 100 Auto Parts Enterprises, National Export Base of Auto Parts, China Top 500 Competitive Large Enterprises, Most Competitive Top 50 of Chinese Non-governmental Enterprises, and its products were awarded as “China Top Brand”

SORL wins the market share with its advantages in technique, quality, product variety, as well as its unique service. Guided by the orientation of market, service, quality, science and technology, the company has been making progress all the time. SORL is dedicating itself to continuously satisfying customers and it believes that it will create a more brilliant future with partners worldwide.

HIGH STANDARD MANUFACTURING

One main factor that's contributed to SORL's improvement in quality has been the implementation and use of modern and advanced equipment. SORL is always looking at the latest manufacturing technology and processes in order to continuously improve productivity and quality. Dedicated to 'quality' SORL makes no compromise when delivering new products to a customer, and ensures all products delivered match the customer's specification. SORL products are second to none and meet global quality standards in their class and range of manufacture. In keeping with this, SORL has put in place rigorous quality control procedures to ensure the supply of products are defect free.



R&D Department



Tooling Workshop



Die-Casting Workshop



Stamping Workshop



Machining Workshop



Assembly Workshop

QUALITY GUARANTEE

Certificate

Standard: **ISO / TS 16949:2009**
07 edition, 2009-04-16

Certificate Register No.: **01 111 019323**
 IATF Certificate No.: **0232036**

Certificate Holder: **Ruili Group Ruian Auto Parts Co., Ltd.**
 No. 2666 Kaitou Avenue, Ruian Development Zone,
 Ruian, Zhejiang Province 325200, P. R. China

Scope: **Design and Manufacturing of Air Brake System Components, Hydraulic Brake System Components, Power Steering Pumps, Electric Parts (Switches, Wiper Blade Assy., Solenoid Valves, Horns, Fuses, Relays and Window Regulators)**

Proof has been furnished by means of an audit that the requirements of ISO / TS 16949:2009 are met.

Issue date/Expiry date: The certificate is valid from 2016-02-15 until 2018-05-14.

Release date: **2016-02-15**

T. Hirsch
 TÜV Rheinland Cert. Grant
 Am Green Gate 11109 Köln
 Germany

TÜVRheinland®
 Precisely Right.

www.tuv.com

РОССИЙСКАЯ ФЕДЕРАЦИЯ
СЕРТИФИКАТ СООТВЕТСТВИЯ
 (обязательная сертификация)

№ **СА-СМТ.14.В.0056** ТР **053268**
См. приложение № 0089443, 008944

ЗАЯВИТЕЛЬ: **"RUILI GROUP RUIAN AUTO PARTS CO., LTD."**, Адрес: No. 1169 YuMeng Road, Ruian Economic Development Zone, Zhejiang, 325200, China. Телефон: 0086-577-8509800, факс: 0086-577-8509031.

ИЗГОТОВИТЕЛЬ: **"RUILI GROUP RUIAN AUTO PARTS CO., LTD."**, Адрес: No. 1169 YuMeng Road, Ruian Economic Development Zone, Zhejiang, 325200, China. Телефон: 0086-577-8509800, факс: 0086-577-8509031.

ОРГАН ПО СЕРТИФИКАЦИИ: **автомобильная инспекция "НАМИ-ФОНТ"**, Москва, 4-й Ломоносовский пер., 17А, ОГРН: 103771912131, Адрес: ул. Я. РоСС RU.0001.11MT14 выдан 17.09.2009. Федеральным агентством по техническому регулированию и метрологии.

НАЗНАЧЕНИЕ ЦЕЛЕЙ: **Зависимые части марки "SORL"** (см. Приложение, Перечень) **близкие части марки "SORL"** (см. Приложение "SORL Commercial Vehicle Parts" для технического обслуживания в ремонт механических транспортных средств. Серийный выпуск.

СООТВЕТСТВИЕ ТРЕБОВАНИЮ: **Технической регламент "О безопасности технического регламента колесных транспортных средств"** (Положение Правительства РФ от 10.09.2009 № 750, с изменениями, принятыми Постановлением Правительства РФ от 10.09.2010 № 706)

ПРОВЕДЕННЫЕ ИССЛЕДОВАНИЯ: Протокол испытаний № 1602925/03, 05.08.2011 г.; № ИСПЫТАНИЕ В ПЕЛЕРЕНИИ: 1603625/714, 05.08.2011 г.; № 16031725/715, 05.08.2011 г.; № 1603252/716, 05.08.2011 г.

ФГУП "НАМИ" (Научно-исследовательский центр производства автомобильной продукции) РОСС RU.0001.21MT01 от 29.06.2009 г.

ПРЕДСТАВЛЕННЫЕ ДОКУМЕНТЫ: Сертификат TUV CERT № 01 111 019323 от 22.04.2016 г. (IATF № 0102005) соответствие системы менеджмента качества требованиям ISO/TS 16949:2009.

СРОК ДЕЙСТВИЯ СЕРТИФИКАТА СООТВЕТСТВИЯ с **05.08.2011** по **31.12.2013**

Руководитель (подпись и печать) **О.И. Гаруцкий**
 Специалист (подпись и печать) **И.И. Малахов**

Certificate of Registration

Intertek

This is to certify that the environmental management system of **Ruili Group Ruian Auto Parts Co., Ltd.**

Registered Address: No. 1169 Yumeng Road, Ruian Economic Development Zone, Zhejiang Province, P. R. China
 Production Address: No. 2666, Development Road, Ruian Economic Development Zone, Zhejiang, P. R. China

has been assessed and registered by Intertek as conforming to the requirements of **ISO 14001: 2004**

The environmental management system is applicable to the management of the environmental aspects related to: **Design, manufacturing and sales of automotive brake system brake components.**

Organization Code: **75906785-X**
 Certificate Number: **7384-EM5**
 Original Issue Date: **18 June 2008**
 Certificate Issue Date: **08 May 2015**
 Certificate Expiry Date: **03 June 2018**

T. Hirsch
 Intertek Certification Limited
 11th Floor, Victoria Road, Quarry Bay, Hong Kong

Certificate of Registration

Intertek

This is to certify that the occupational health & safety management system of **Ruili Group Ruian Auto Parts Co., Ltd.**

Registered Address: No. 1169 Yumeng Road, Ruian Economic Development Zone, Zhejiang Province, P. R. China
 Production Address: No. 2666, Development Road, Ruian Economic Development Zone, Zhejiang, P. R. China

has been assessed and registered by Intertek as conforming to the requirements of **OHSAS 18001: 2007**

The occupational health & safety management system is applicable to the management of occupational health and safety risks associated with: **Design, manufacturing and sales of automotive brake system brake components.**

Organization Code: **75906785-X**
 Certificate Number: **7384-CH5**
 Original Issue Date: **08 August 2006**
 Certificate Issue Date: **08 May 2015**
 Certificate Expiry Date: **30 May 2018**

T. Hirsch
 Intertek Certification Limited
 11th Floor, Victoria Road, Quarry Bay, Hong Kong

SORL adopts a number of advanced management systems, especially ISO/TS16949 which is specially required by the international auto industry, to control the whole process of production, from designing, manufacturing, packing to aftermarket service, ensuring the stability and consistency of products. Recently the company is actively bringing in Six Sigma Management to achieve further improvement.

TABLE OF CONTENT

Page	Products
1-8	Combination Switch
9-14	Alternator & Motor
14-23	Wiper Arm & Blade
24-27	Power Switch
28-30	Ignition Switch
31-34	Electric Cable & Air Hose
35-36	Fuse Box & Fuse
37-38	Jump-Start Relay
39-54	Rocker Switch
55-57	Window & Door Parts
58-66	Flasher & Relay
67-68	Electronic Regulator
69-73	Electric & Air Horn
74-84	Solenoid Valve
85-86	Tank Cap
86-87	Diesel Oil Dobber
87-90	Switch & Others
90-96	Shift Knob
97-100	Meter
100-108	Sensor & Switch



INDEX BY ORIGINAL NUMBERS

Cross Ref.	SORL No.	Drawing No.	Page	Cross Ref.	SORL No.	Drawing No.	Page
0000180702	RLD5-Z009	3711 010 001 0	85	0025451234	RLD5-G016	3722 014 001 0	36
0000401908	RLD5-Z004	3711 006 001 0	85	0025452407	RLD5-I004	3792 002 013 0	51
000295970	RLD5-B015	3741 011 001 0	9	0025453990	RLD5-Z053	3758 006 001 0	88
0005015315	RLD5-Z001	3711 003 001 0	85	0025457124	RLD5-L003	3792 501 001 0	66
0005016415	RLD5-Z004	3711 006 001 0	85	0028203042	RLD5-B006	3741 003 001 0	9
0005017215	RLD5-Z006	3711 007 001 0	85	0035423305	6491 1101	3808 102 002 0	97
0005429716	6492 2221	3813 104 004 0	98	0035443032	RLD5-K025	3766 010 001 0	59
0005431015	RLD5-K071	3766 023 001 0	63	0035443732	RLD5-K025	3766 010 001 0	59
0005431915	RLD5-K071	3766 023 001 0	63	0035444332	RLD5-K025	3766 010 001 0	59
0005432415	RLD5-K071	3766 023 001 0	63	0035445032	RLD5-K025	3766 010 001 0	59
0005432815	RLD5-K071	3766 023 001 0	63	0035445332	RLD5-K063	3766 001 001 0	61
0005437815	RLD5-K071	3766 023 001 0	63	0035446132	RLD5-K025	3766 010 001 0	59
0005438915	RLD5-K073	3722 003 002 0	63	0035457990	RLD5-I004-06	3792 002 030 0	51
0005439015	RLD5-K072	3722 003 001 0	63	0035458105	RLD5-K053	3735 038 001 0	65
0005439015	RLD5-K071	3766 023 001 0	63	0035458124	RLD5-A015	3774 044 002 0	3
0005451324	RLD5-K070	3735 023 002 0	63	003545832	RLD5-A033	3774 049 001 0	4
0005452508	RLD5-D011	3736 006 001 0	26	0035458324	RLD5-A015	3774 044 002 0	3
0005453013	RLD5-E006	3704 009 001 0	28	0035458724	RLD5-A014	3774 044 001 0	2
0005453013	RLD5-E012	3704 002 004 0	29	0035459390	RLD5-I004-12	3792 002 034 0	51
0005453704	RLD5-Z047	3709 001 001 0	88	0038202742	RLD5-B006	3741 003 001 0	9
0005454704	RLD5-Z047	3709 001 001 0	88	0038205042	RLD5-B006	3741 003 001 0	9
0005455413	RLD5-E028	3704 401 001 0	30	0045424317	6499 1105	3810 201 001 0	100
0005456017	RLD5-Z038	3871 005 001 0	87	0045450207	RLD5-I055	3790 002 001 0	42
0005456314	RLD5-Z084	4101 054 001 0	89	0045450224	RLD5-L001	3792 507 002 0	66
0005456704	RLD5-Z047	3709 001 001 0	88	0045451124	RLD5-A008	3774 012 002 0	2
0005456909	RLD5-M023	4101 040 001 0	105	0045453924	RLD5-A008	3774 012 002 0	2
0005458108	RLD5-E027	3704 300 001 0	30	0045454224	RLD5-A007	3774 012 001 0	2
0005458308	RLD5-E010	3704 002 002 0	28	0045455324	RLD5-A008	3774 012 002 0	2
0005458401	RLD5-G008	3722 002 004 0	34	0045458124	RLD5-A009	3774 012 003 0	2
0005458408	RLD5-D011	3736 006 001 0	26	0048206742	RLD5-B006	3741 003 001 0	9
0005458501	RLD5-G009	3722 002 005 0	34	0051545102	RLD5-B002	3741 056 001 0	9
0005459311	RLD5-L004	3792 509 001 0	66	0055429417	6499 4215	3802 451 001 0	102
0008209010	RLD5-I028	3792 027 001 0	39	0055451024	RLD5-A007	3774 012 001 0	2
000824401	RLD5-B010	3741 045 001 0	10	0055453824	RLD5-A007	3774 012 001 0	2
0008693621	RLD5-B015	3741 011 001 0	9	0055455124	RLD5-A007	3774 012 001 0	2
000947	RLD5-I081	3746 001 003 0	44	0055455224	RLD5-A008	3774 012 002 0	2
0012033975	RLD5-Z076	4101 622 001 0	90	0055458690	RLD5-I004-07	3792 002 035 0	51
0012033975	RLD5-Z077	4101 622 002 0	90	0055459224	RLD5-I007-01	3792 003 001 0	45
0014621130	RLD5-E002	3704 003 001 0	28	0065252	RLD5-I082	3746 001 004 0	44
0015421119	RLD5-K048	3766 038 002 0	65	0065450626	RLD5-F003	3730 004 001 0	31
0015422317	6499 3210	3808 305 001 0	100	0065452990	RLD5-I004-05	3792 002 044 0	51
0015424016	6492 2110	3810 000 000 0	98	0065457824	RLD5-A013	3774 012 004 0	2
0015424202	6496 2205	3810 002 003 0	97	0075424317	6492 1216	3802 104 003 0	98
0015428716	6492 2109	3813 104 001 0	98	0075456417	RLD5-I057	3790 002 002 0	41
0015429318	RLD5-M055	1608 101 001 0	108	0085422206	6492 1104	3802 104 001 0	98
0015429902	6496 2101	3810 002 002 0	97	0085450124	RLD5-A012	3774 024 001 0	2
0015450214	RLD5-Z054	4101 101 001 0	88	0085457590	RLD5-I004-04	3792 002 009 0	51
0015450626	RLD5-F003	3730 004 001 0	31	008601226	RLD5-B015	3741 011 001 0	9
0015451815	RLD5-Z053	3758 006 001 0	88	008603226	RLD5-B015	3741 011 001 0	9
0015454914	RLD5-Z054	4101 101 001 0	88	008693121	RLD5-B012	3741 012 001 0	9
0018241501	RLD5-B004	3741 009 002 0	9	0091540702	RLD5-B001	3741 055 001 0	9
0022033275	RLD5-Z077	4101 622 002 0	90	01163920	RLD5-Z038	3871 005 001 0	87
0022035475	RLD5-Z077	4101 622 002 0	90	0120469982	RLD5-B001	3741 055 001 0	9
002472043	RLD5-R061	3754 055 001 0	80	0120489728	RLD5-B002	3741 056 001 0	9
0025405847	6489 2112	3820 201 006 0	99	0125422417	RLD5-Z141	3802 452 003 0	103
0025421105	6491 1203	3808 102 001 0	97	0125424717	RLD5-Z144	3802 601 007 0	103
0025426820	RLD5-P008	3721 002 0020	69	0135426217	RLD5-Z146	3802 601 008 0	104
0025427317	6499 3208	3808 211 001 0	100	0142001	RLD5-E012	3704 002 004 0	29
0025429203	6496 1102	3806 102 002 0	97	0145424117	RLD5-Z143	3802 452 004 0	103
0025429203	6496 1204	3806 102 003 0	98	015424819	RLD5-K017	3735 006 001 0	62
0025450734	RLD5-G016	3722 014 001 0	36	01913200	RLD5-A044	3774 026 001 0	5
0025450834	RLD5-G016	3722 014 001 0	36	0192033001,02,04	RLD5-N017	3702 002 001 0	68
0025450934	RLD5-G016	3722 014 001 0	36	0192033003	RLD5-N016	3702 002 002 0	68
0025451034	RLD5-G016	3722 014 001 0	36	0192033005	RLD5-N016	3702 002 002 0	68

INDEX BY ORIGINAL NUMBERS

Cross Ref.	SORL No.	Drawing No.	Page	Cross Ref.	SORL No.	Drawing No.	Page
0192052001	RLD5-N007	3702 007 001 0	67	119731234	RLD5-N005	3702 010 003 0	67
0192052002	RLD5-N007	3702 007 001 0	67	119731239	RLD5-N005	3702 010 003 0	67
0192052090	RLD5-N007	3702 007 001 0	67	119731513	RLD5-N005	3702 010 003 0	67
0192053006	RLD5-N001	3702 001 001 0	67	119731514	RLD5-N005	3702 010 003 0	67
0192053011	RLD5-N001	3702 001 001 0	67	12017.0159	RLD5-J006A	3787 008 002 0	57
0192053013	RLD5-N001	3702 001 001 0	67	12135165	RLD5-I067	3746 011 001 0	43
022039175	RLD5-Z076	4101 622 001 0	90	1232316	RLD5-R061	3754 055 001 0	80
02482029	RLD5-E012	3704 002 004 0	29	1235010105	RLD5-Z003	3711 005 001 0	85
0265421317	RLD5-Z145	3802 452 005 0	104	1235014615	RLD5-Z006	3711 007 001 0	85
02910770	RLD5-E015	3704 001 001 0	29	1245000106	RLD5-Z003	3711 005 001 0	85
02-9432.00	RLD5-D010	3736 015 001 0	26	1245010515	RLD5-Z003	3711 005 001 0	85
0301877	6499 1110	3810 202 001 0	100	1248200110	RLD5-I029	3792 019 001 0	39
0302238	RLD5-E012	3704 002 004 0	29	1295000006	RLD5-Z003	3711 005 001 0	85
03056	RLD5-Z073	3792 048 001 0	88	130009	RLD5-E006	3704 009 001 0	28
0341002003	RLD5-D009	3736 006 002 0	25	1301750	RLD5-F003	3730 004 001 0	31
034130021	RLD5-D002	3703 001 001 0	25	1308617300008		1705 002 004 0	95
0342106005	RLD5-E007	3704 018 001 0	28	1337453	RLD5-H001	3735 049 001 0	37
0342106005	RLD5-E012	3704 002 004 0	29	1341796	RLD5-P013	3798 301 001 0	70
0342106009	RLD5-E012	3704 002 004 0	29	1363131	RLD5-I025	3792 009 001 0	41
0342309004	RLD5-E012	3704 002 004 0	29	1369975	RLD5-Z090B	1705 506 003 0	90
0342309006	RLD5-E011	3704 002 003 0	29	1440217	RLD5-A072	3774 039 001 0	6
0342309008	RLD5-E010	3704 002 002 0	28	1441235	RLD5-Z131	1705 523 001 0	93
0347893	RLD5-A021	3774 019 001 0	3	1470633	RLD5-R050	3754 012 052 0	78
0501208141	RLD5-M023	4101 040 001 0	105	1514259	RLD5-P013	3798 301 001 0	70
0502877	RLD5-E010	3704 002 002 0	28	15590707	RLD5-I068	3746 012 001 0	43
05080172AA	RLD5-Z009	3711 010 001 0	85	15590708	RLD5-I069	3790 012 002 0	43
066500-0791	RLD5-K043	3766 034 001 0	60	15602610	RLD5-I070	3790 012 003 0	43
0678792	RLD5-Z073	3792 048 001 0	88	1578073	RLD5-A030	3774 041 005 0	4
068500-2900	RLD5-K002	3766 007 001 0	58	1578700-5	RLD5-I003	3792 001 003 0	39
0745582	RLD5-R061	3754 055 001 0	80	1578702	RLD5-I002	3792 001 002 0	39
08010100	RLD5-D007	3703 004 001 0	25	1578704	RLD5-I001	3792 001 001 0	39
083865039	RLD5-A033	3774 049 001 0	5	1585878	RLD5-B012	3741 012 001 0	9
1.21087	RLD5-E025	3704 301 001 0	29	1587058	RLD5-A030	3774 041 005 0	4
1020180080	RLD5-Z009	3711 010 001 0	85	1587698	RLD5-D009	3736 006 002 0	25
1020180302	RLD5-Z009	3711 010 001 0	85	1591034	RLD5-R061	3754 055 001 0	80
1020180380	RLD5-Z009	3711 010 001 0	85	1594958	RLD5-A030	3774 041 005 0	4
1020180402	RLD5-Z009	3711 010 001 0	85	1594959-1	RLD5-A019	3774 048 001 0	3
1020180802	RLD5-Z009	3711 010 001 0	85	16100720020	RLD5-M020	3758 003 001 0	106
1020469686	RLD5-B001	3741 055 001 0	9	1615081	RLD5-A072	3774 039 001 0	6
10221254	RLD5-I066	3746 021 001 0	43	162.0084	RLD5-N015	3702 004 002 0	67
10318809	RLD5-I065	3746 010 001 0	43	1639096	RLD5-R053	3754 012 037 0	79
1073020-810		1705 002 025 0	96	1655853	RLD5-Z113	1705 509 001 0	92
1096413	RLD5-A022A	3774 022 001 0	3	1665981	RLD5-Z120	1705 512 001 0	92
1101710-Q407	RLD5-Z115	3711 002 002 0	86	167771	RLD5-Z073	3792 048 001 0	88
11062023	RLD5-R050	3754 012 052 0	78	1703020AA9K		1705 002 003 0	95
1110180302	RLD5-Z009	3711 010 001 0	85	1703020BJH800		1705 002 022 0	96
11125026	RLD5-N017	3702 002 001 0	68	1703020-BQ109		1705 002 008 0	95
11125105	RLD5-N017	3702 002 001 0	68	1703020-BQ509		1705 502 019 0	95
111281700002		1705 002 005 0	95	1703020-BQ802		1705 002 011 0	95
11253	RLD5-R026	3754 008 002 0	76	1703020-BQ836		1705 502 020 0	95
11271	RLD5-R025	3754 008 001 0	76	1703020-BQ902		1705 002 027 0	96
1139129712	RLD5-E012	3704 002 004 0	29	1703025-739/B		1705 002 010 0	95
11635831	RLD5-N017	3702 002 001 0	68	1703040-D649G		1705 002 024 0	96
1179311090	RLD5-N007	3702 007 001 0	67	1716013	RLD5-E012	3704 002 004 0	29
1197311021	RLD5-N006	3702 011 001 0	67	1716022	RLD5-E010	3704 002 002 0	28
1197311026	RLD5-N003	3702 009 002 0	67	1727377	RLD5-Z130	1705 522 001 0	93
1197311027	RLD5-N003	3702 009 002 0	67	174.6933	RLD5-Z133	1705 525 001 0	93
1197311028	RLD5-N003	3702 009 002 0	67	174.6934	RLD5-Z134	1705 526 001 0	94
1197311035	RLD5-N003	3702 009 002 0	67	1771638	RLD5-P013	3798 301 001 0	70
1197311038	RLD5-N003	3702 009 002 0	67	1784671	RLD5-P013	3798 301 001 0	70
1197311040	RLD5-N003	3702 009 002 0	67	179100580024	RLD5-G025	3722 008 001 0	35
1197311041	RLD5-N003	3702 009 002 0	67	179100580025	RLD5-G026	3722 008 002 0	35
1197311213	RLD5-N004	3702 010 001 0	67	179100580059	RLD5-I056-10	3792 001 004 0	50
119731232	RLD5-N005	3702 010 003 0	67	179100580060	RLD5-I056-09	3792 001 005 0	50

INDEX BY ORIGINAL NUMBERS

Cross Ref.	SORL No.	Drawing No.	Page	Cross Ref.	SORL No.	Drawing No.	Page
179100580062	RLD5-I056-02	3792 001 008 0	49	284554500143	RLD5-A105	3774 051 001 0	7
179100580067	RLD5-I056-06	3792 001 011 0	50	284554500145	RLD5-I074	3792 051 001 0	42
179100580068	RLD5-I056-05	3792 001 010 0	50	286649	RLD5-Z045	4101 024 001 0	87
179100580070	RLD5-I056-07	3792 001 012 0	50	289654509907	RLD5-A107	3774 053 002 0	7
179100580071	RLD5-I056-08	3792 001 013 0	50	297.840	RLD5-A052	3774 028 001 0	5
179100580076	RLD5-I056-03	3792 001 006 0	49	301491	RLD5-A021	3774 019 001 0	3
179100580101	RLD5-I056-04	3792 001 009 0	49	3031673	RLD5-E012	3704 002 004 0	29
179100580187	RLD5-I056-01	3792 001 007 0	49	305035140002	RLD5-R084	3754 003 054 0	83
1874273	RLD5-P013	3798 301 001 0	70	3088-A6913	RLD5-Z100	1705 502 002 0	91
1874274	RLD5-P013	3798 301 001 0	70	3088-A6915	RLD5-Z101	1705 502 001 0	91
192053005	RLD5-N001	3702 001 001 0	67	309035140001	RLD5-R089	3754 001 028 0	83
199000580141	RLD5-Z044	3725 001 001 0	89	3136A	RLD5-Z033	4101 211 001 0	87
1B24937500006	RLD5-K006	3735 027 001 0	61	3172170	RLD5-A022B	3774 022 002 0	4
1B2493750002	RLD5-K013	3766 029 001 0	62	3227250202	RLD5-J016	3789 003 001 0	55
1B24937500031	RLD5-K005	3766 022 001 0	58	3227250302	RLD5-J017	3789 003 002 0	55
1B24937500031	RLD5-K047	3766 021 001 0	60	331490001	RLD5-K042	3766 033 001 0	66
1B2493750004	RLD5-K009	3735 030 001 0	61	341915060	RLD5-D007	3703 004 001 0	25
200994	RLD5-A052	3774 028 001 0	5	3435400045		3774 004 016 0	1
201094	RLD5-A034	3774 050 001 0	5	3440187002	RLD5-Z009	3711 010 001 0	85
201095	RLD5-A020	3774 048 002 0	3	3504607004	RLD5-E002	3704 003 001 0	28
201259	RLD5-A017	3774 006 001 0	3	353628	RLD5-I056	3792 032 001 0	41
201563	RLD5-A019	3774 048 001 0	3	35490100118	RLD5-R085	3754 003 035 0	83
201726	RLD5-A023	3774 021 001 0	4	35490100138	RLD5-R086	3754 003 038 0	83
201918	RLD5-A007	3774 012 001 0	2	3549010-E15	RLD5-R039	3754 003 022 0	77
202024	RLD5-A041	3774 020 002 0	5	3549010-E46	RLD5-R073	3754 003 055 0	81
202356	RLD5-A010	3774 013 002 0	2	3549010-E7	RLD5-R073	3754 003 055 0	81
2025000406	RLD5-Z003	3711 005 001 0	85	3549010-E8	RLD5-R074	3754 003 052 0	81
2025450081	RLD5-Z117A	3709 001 036 8	89	35490130078	RLD5-R096	3754 014 003 0	84
202641	RLD5-A045	3774 027 001 0	5	35490130098	RLD5-R097	3754 014 005 0	84
203.102	RLD5-A022A	3774 022 001 0	3	35490380018	RLD5-R083	3754 003 031 0	82
20488052	RLD5-Z112	1705 508 001 0	91	3557-10-00005	RLD5-R087	3754 001 013 0	83
20488058	RLD5-Z123	1705 515 001 0	92	3557-10-0008	RLD5-R090	3754 001 030 0	83
20488061	RLD5-Z122	1705 514 001 0	92	3575400045	RLD5-A005	3774 004 005 0	1
20488063	RLD5-Z121	1705 513 001 0	92	3575400145	RLD5-A006	3774 004 006 0	1
20493844	RLD5-Z121	1705 513 001 0	92	3575400145		3774 004 027 0	1
20797836	RLD5-A022A	3774 022 001 0	3	3575400245		3774 004 012 0	1
21568629	RLD5-D026	3736 006 003 0	26	3575400345		3774 004 013 0	1
2197311090	RLD5-N007	3702 007 001 0	67	35AD-14010-4	RLD5-R068	3754 012 013 0	81
2197311301	RLD5-N009	3702 009 002 0	67	35AD-14010-5	RLD5-R069	3754 012 014 0	81
222600045	RLD5-Z126	1705 518 001 0	93	35AD-49020DF357	RLD5-R013	3754 031 001 0	75
228600	RLD5-M022	4101 039 001 0	105	360247	RLD5-A023	3774 021 001 0	4
228750	RLD5-M026	3757 003 001 0	106	360248	RLD5-A024	3774 020 001 0	4
234387	RLD5-Z066	4101 615 001 0	88	3611105-79A	RLD5-R031	3754 001 025 0	77
240315	RLD5-D009	3736 006 002 0	25	361552MN1247	RLD5-E008	3704 202 003 0	28
2404233	RLD5-B056	3741 065 001 0	13	3638010-C0100	RLD5-K079	3735 058 001 0	64
2410100H3J10	RLD5-R067	3754 003 015 0	81	3645457624	RLD5-A052	3774 028 001 0	5
24762043	RLD5-R061	3754 055 001 0	80	367326	RLD5-A021	3774 019 001 0	3
251291	RLD5-A026	3774 017 001 0	4	367326	RLD5-A021	3774 019 001 0	3
252490	RLD5-A037	3774 025 001 0	5	3675400245		3774 004 015 0	1
252491	RLD5-A053	3774 025 002 0	5	36A3D-35001	RLD5-M021	3757 004 001 0	107
25452407	RLD5-I004	3792 002 013 0	51	36A43D-40020	RLD5-K082	3766 055 002 0	61
25558081	RLD5-I071	4101 608 001 0	43	36A43D-40021	RLD5-K081	3766 055 001 0	61
25560-15G05	RLD5-A047	3774 016 001 0	6	3704110-Q435	RLD5-E034	3704 024 001 0	30
26310DB810	RLD5-P044	3798 002 008 0	72	3708010	RLD5-E019	3704 017 001 0	29
269954510164	RLD5-I078	3746 015 001 0	44	3709010-50	RLD5-A029	3774 002 001 0	4
270254509976	RLD5-A110	3774 055 001 0	7	371910	RLD5-E025	3704 301 001 0	30
276560340	RLD5-E010	3704 002 002 0	28	3721115-116ADF152A	RLD5-R020	3754 021 001 0	84
276590370	RLD5-Z038	3871 005 001 0	87	3722080-382	RLD5-D030	3736 017 001 0	27
276599	RLD5-M045	3757 003 003 0	106	3722080-50A	RLD5-D030A	3736 017 003 0	27
282154500102	RLD5-A112	3774 058 001 0	8	3726030-50	RLD5-K014	3766 004 001 0	58
282354500102	RLD5-I077	3746 014 001 0	44	3729100-116	RLD5-M052	4101 019 001 0	108
283054509909	RLD5-A108	3774 054 001 0	7	3729100-240	RLD5-M053	4101 022 001 0	108
283054509911	RLD5-A108A	3774 054 002 0	7	3735010EA01/D	RLD5-A120	3774 002 012 0	8
284354500101	RLD5-A111	3774 057 001 0	7	3735015-C0100	RLD5-K075	3766 009 001 0	61

INDEX BY ORIGINAL NUMBERS

Cross Ref.	SORL No.	Drawing No.	Page	Cross Ref.	SORL No.	Drawing No.	Page
3735020-C0100	RLD5-K074	3735 011 001 0	63	4255400045		3774 004 024 0	1
3736020-DL02A	RLD5-D027	3703 001 015 0	27	43241	RLD5-I037	3792 010 001 0	39
3751030-0219	RLD5-R078	3754 003 017 0	82	4375400045		3774 004 025 0	1
3754010-0598	RLD5-R079	3754 012 033 0	82	4375400145		3774 004 026 0	1
3754010-1K7	RLD5-R077	3754 003 050 0	82	440334	RLD5-A129	3774 002 006 0	8
3754010-240	RLD5-R080	3754 003 001 0	82	4410400150	RLD5-M046	3802 121 001 0	107
3754010-369	RLD5-R075	3754 003 012 0	81	4410441080	RLD5-M047	3802 122 001 0	107
3754010A8E	RLD5-R011	3754 002 010 0	75	4410501000	RLD5-M042	3757 099 002 0	107
3754010A8E	RLD5-R010	3754 002 011 0	75	4410501230	RLD5-M041	3757 099 001 0	107
3754010K1H(DF252)	RLD5-R008	3754 001 014 0	74	443815432020	RLD5-D008	3736 007 001 0	25
3754010-Q304	RLD5-R004	3754 001 015 0	74	443815432020-B	RLD5-D030	3736 007 002 0	27
3754010-Q320	RLD5-R003	3754 001 007 0	74	45020-12-11	RLD5-E016	3704 012 001 0	29
3754010-Q422	RLD5-R006	3754 001 005 0	74	45020-12-6	RLD5-E024	3704 012 002 0	28
3754020-260	RLD5-R081	3754 003 002 0	82	460516	RLD5-J005A	3787 009 002 0	57
3754030A8E	RLD5-M017	3754 601 001 0	106	4630550500	RLD5-Z118	1705 510 001 0	92
3754030-D598	RLD5-R076	3754 003 046 0	82	4630550520	RLD5-Z120	1705 512 001 0	92
3754030-D849	RLD5-R082	3754 003 044 0	82	4720706390	RLD5-R048	3754 012 049 0	78
3754030-Q422K	RLD5-R005	3754 001 006 0	74	4720726390	RLD5-R049	3754 012 050 0	78
37570421008	RLD5-R099	3754 049 002 0	84	4721271400	RLD5-R061	3754 055 001 0	80
3757050-435	RLD5-M050	3757 601 005 0	107	4721706060	RLD5-R050	3754 012 052 0	78
3763040C170	RLD5-K065	3735 019 001 0	62	4721706160	RLD5-R051	3754 012 045 0	78
3765400145		3774 004 017 0	1	4721707960	RLD5-R052	3754 012 054 0	79
3774010-109	RLD5-M054	4101 023 001 0	108	4721710000	RLD5-R053	3754 012 037 0	79
3774010-367	RLD5-M051	4101 028 008 0	108	4721716860	RLD5-R057	3754 012 046 0	79
37AD-25010	RLD5-Z043	3725 003 001 0	89	4721717000	RLD5-R054	3754 012 051 0	79
37AD-35010	RLD5-D001	3736 001 004 0	24	4721717060	RLD5-R055	3754 012 048 0	79
37AD-46030	RLD5-I033	3790 008 001 0	42	4721727860	RLD5-R059	3754 012 047 0	80
37AD-46040	RLD5-I032	3790 008 002 0	42	4721732260	RLD5-R058	3754 012 038 0	79
37AD-68010	RLD5-I030	3792 012 001 0	39	4786024	RLD5-Z073	3792 048 001 0	88
37AD-83010	RLD5-I020	3792 502 001 0	41	490102	RLD5-E012	3704 002 004 0	29
37AD-86011	RLD5-I034	3792 018 001 0	42	4DM001863-08	RLD5-K004	3766 027 001 0	58
37N-54010	RLD5-R009	3754 002 006 0	75	4DW004356-00	RLD5-K001	3766 020 001 0	58
37N-54010(DF251)	RLD5-R009	3754 002 006 0	75	4DW004834-12	RLD5-K003	3766 019 001 0	58
37Z63J-35510	RLD5-K078	3735 059 001 0	63	4RA0035100814P	RLD5-K007	3735 028 001 0	64
37ZB1-36010	RLD5-D024	3703 005 001 0	26	5001844056	RLD5-R023	3759 026 001 0	76
3801010-367	6489 1505	3801 004 001 0	100	5005429190	RLD5-I004-23	3792 002 050 0	51
3801010B1-Q126A	6489 1404	3801 003 002 0	100	5005453390	RLD5-I004-13	3792 002 031 0	51
3801010-Q422H	6489 1406	3801 003 001 0	100	5005455001	RLD5-G012	3722 001 001 0	34
3801-16140	RLD5-K016	3735 016 001 0	62	5005455490	RLD5-I004-15	3792 002 043 0	51
3801-16510	RLD5-K012	3766 028 001 0	62	5005458401	RLD5-G009	3722 002 005 0	34
3814660901	RLD5-J004A	3787 010 001 0	56	5005458401	RLD5-G007	3722 002 001 0	34
3817230001	RLD5-J001A	3787 015 002 0	55	5005459290	RLD5-I004-17	3792 002 051 0	51
3817230301	RLD5-J001	3787 015 001 0	55	5006305805	RLD5-R053	3754 012 037 0	79
3817600259	RLD5-J004A	3787 010 001 0	56	5010347977	RLD5-R050	3754 012 052 0	78
3817660901	RLD5-J004A	3787 010 001 0	56	5095454290	RLD5-I004-25	3792 002 048 0	51
3818080-240	RLD5-K010	3735 031 001 0	62	5095454390	RLD5-I004-25	3792 002 045 0	51
3818200241	RLD5-C002	5205 037 002 0	14	5095454490	RLD5-I004-25	3792 002 047 0	51
3818240301	RLD5-B005	3741 009 001 0	9	5095459124	RLD5-I007-02	3792 003 002 0	45
3818244810	RLD5-B005	3741 009 001 0	9	5114340001	RLD5-R088	3754 001 017 0	83
384970	RLD5-Z090A	1705 506 002 0	90	5115455090	RLD5-I004-14	3792 002 042 0	51
384970	RLD5-Z090B	1705 506 003 0	90	5115459324	RLD5-I007-04	3792 003 004 0	45
397580003	RLD5-Z038	3871 005 001 0	87	5115459424	RLD5-I007-07	3792 003 007 0	45
3987034	RLD5-D009	3736 006 002 0	25	5115459524	RLD5-I007-05	3792 003 005 0	45
3T361989040	RLD5-J018	3789 005 001 0	56	5115459624	RLD5-I007-06	3792 003 006 0	45
4.61015	RLD5-E028	3704 401 001 0	30	51259020009	RLD5-R061	3754 055 001 0	80
402.110,24	RLD5-B010	3741 045 001 0	10	51261017148	RLD5-B002	3741 056 001 0	9
402308	RLD5-B006	3741 003 001 0	9	51261017201	RLD5-B001	3741 055 001 0	9
403071	RLD5-B006	3741 003 001 0	9	51261019201	RLD5-B001	3741 055 001 0	9
403873	RLD5-B006	3741 003 001 0	9	513000LOT120753	RLD5-E033	3704 023 001 0	30
406629	RLD5-B006	3741 003 001 0	9	5135450190	RLD5-I004-16	3792 002 053 0	51
407071	RLD5-B006	3741 003 001 0	9	514259	RLD5-P013	3798 301 001 0	70
41025616	RLD5-R050	3754 012 052 0	78	5145450124	RLD5-I019	3790 006 001 0	42
41822394	RLD5-Z054	4101 101 001 0	88	5184310110	RLD5-R062	3754 012 020 0	80
42546462	RLD5-R053	3754 012 037 0	79	5184310210	RLD5-R063	3754 012 021 0	80

INDEX BY ORIGINAL NUMBERS

Cross Ref.	SORL No.	Drawing No.	Page	Cross Ref.	SORL No.	Drawing No.	Page
5184310310	RLD5-R064	3754 012 022 0	80	70495271	RLD5-M019	4101 038 001 0	105
5184310410	RLD5-R065	3754 012 023 0	80	7311080000	RLD5-Z054	4101 101 001 0	88
5184310510	RLD5-R066	3754 012 024 0	80	7332017000	RLD5-A016	3774 006 024 0	3
5188200142	RLD5-B052	3741 003 010 0	12	736924	RLD5-R061	3754 055 001 0	80
5205450190	RLD5-I004-18	3792 002 056 0	51	736925	RLD5-R061	3754 055 001 0	80
5205450290	RLD5-I004-20	3792 002 055 0	51	7420915349	RLD5-Z139	1705 531 001 0	94
5205450490	RLD5-I004-21	3792 002 057 0	51	79100580021	RLD5-G012	3722 001 001 0	34
5205450590	RLD5-I004-22	3792 002 058 0	51	79100580160	RLD5-K015	3766 002 001 0	58
5215455090	RLD5-I004-01	3792 002 033 0	51	79100580346	RLD5-A017	3774 006 001 0	3
5215455190	RLD5-I004-08	3792 002 036 0	51	80545491	RLD5-Z084	4101 054 001 0	89
5215455290	RLD5-I004-03	3792 002 009 0	51	80933003001	RLD5-Z047	3709 001 001 0	88
5215455390	RLD5-I004-24	3792 002 049 0	51	81.25503.0130	RLD5-L001	3792 507 002 0	66
5215459424	RLD5-I007-08	3792 003 008 0	45	81.25505.6302	RLD5-I049	3792 036 007 0	41
52310-Y3B00	RLD5-R070	3754 012 030 0	81	81.25505.6326	RLD5-I048	3792 036 006 0	47
52310-Y5C0G	RLD5-R071	3754 001 034 0	81	81.25505.6607	RLD5-I050	3792 036 008 0	47
532941	RLD5-R061	3754 055 001 0	80	81.25509.0013	RLD5-A044	3774 026 001 0	5
5446209	RLD5-Z038	3871 005 001 0	87	81.25509.0028	RLD5-A010	3774 013 002 0	2
5446290	RLD5-Z038	3871 005 001 0	87	81.25509.0093	RLD5-A010	3774 013 002 0	2
5451630	RLD5-Z073	3792 048 001 0	88	81.25509.0119	RLD5-A010	3774 013 002 0	2
5452319	RLD5-Z073	3792 048 001 0	88	81.25509.0124	RLD5-A010	3774 013 002 0	2
5459915	RLD5-Z073	3792 048 001 0	88	81.25509.9724	RLD5-A011	3774 013 001 0	2
551154500102	RLD5-A106	3774 052 001 0	7	81.25520.0087	RLD5-M019	4101 038 001 0	105
551154500401	RLD5-I072	3792 047 001 0	42	81.25520.0152	RLD5-M019	4101 038 001 0	105
551754501620	RLD5-A127	3774 064 001 0	8	81.25520-0134	RLD5-M028	4101 605 001 0	105
5645459324	RLD5-I007-03	3792 003 003 0	45	81.25520-0171	RLD5-M028	4101 605 001 0	105
5715450124	RLD5-A126	3774 004 009 0	8	81.25907.0225	RLD5-I051	3792 011 001 0	44
5715450224	RLD5-A126A	3774 004 010 0	8	81.25937-0040	RLD5-M041	3757 099 001 0	107
5755065	RLD5-E010	3704 002 002 0	28	81.26401.6134	RLD5-B008	3741 003 002 0	10
585LL	RLD5-Z082	1705 501 001 0	90	81.26411.6089	RLD5-C004	5205 033 001 0	15
5865459224	RLD5-I007-09	3792 003 009 0	45	81.26411.6090	RLD5-C024	5205 033 002 0	15
59000580048	RLD5-E018	3704 002 001 0	29	81.26430.0083	RLD5-C053	5205 502 013 0	20
6002026	RLD5-B002	3741 056 001 0	9	81.26430.0113	RLD5-C053	5205 502 005 0	20
6115400066	RLD5-I075	3792 003 013 0	41	81.26485.6030	RLD5-B003	3741 010 001 0	9
61673540	RLD5-Z076	4101 622 001 0	90	81.26485-6016	RLD5-B015	3741 011 001 0	9
6202600040	RLD5-Z068	1705 504 001 0	90	81.46433.6006	RLD5-E008	3704 202 003 0	28
6205400045	RLD5-A001	3774 004 001 0	1	81200171	RLD5-M028	4101 605 001 0	105
6205400145	RLD5-A002	3774 004 002 0	1	81253110005	RLD5-K051	3766 008 001 0	60
6205400624	RLD5-K070	3735 023 002 0	63	81253110006	RLD5-K051A	3766 008 002 0	60
621730	RLD5-D011	3736 006 001 0	26	81253110009	RLD5-K051	3766 008 001 0	60
6317601259	RLD5-J004A	3787 010 001 0	56	81253110010	RLD5-K051A	3766 008 002 0	60
6375400145		3774 004 014 0	1	81253110012	RLD5-K051	3766 008 001 0	60
6417200246	RLD5-J002	3789 004 001 0	55	81253110013	RLD5-K051A	3766 008 002 0	60
6417200346	RLD5-J003	3789 004 002 0	55	81253110023	RLD5-K052	3735 009 001 0	62
6417600259	RLD5-J009	3787 011 001 0	57	81253110024	RLD5-K051	3766 008 001 0	60
6417600359	RLD5-J009A	3787 011 002 0	57	81253110025	RLD5-K051	3766 008 001 0	60
6504620030	RLD5-E031	3704 003 001 0	30	81253110026	RLD5-K051A	3766 008 002 0	60
6554620030	RLD5-E031	3704 003 001 0	30	81253110027	RLD5-K051	3766 008 001 0	60
6555400045	RLD5-A141	3774 004 023 0	1	81253110028	RLD5-K051A	3766 008 002 0	60
6555400145	RLD5-A003	3774 004 003 0	1	81255016005	RLD5-E012	3704 002 004 0	29
6555400445	RLD5-A004	3774 004 004 0	1	81255016030	RLD5-E010	3704 002 002 0	28
65A00078	RLD5-P013	3798 301 001 0	70	81255016033	RLD5-E026	3704 302 001 0	30
6606Z06-010	RLD5-R014	3754 016 001 0	75	81255090020	RLD5-A041	3774 020 002 0	5
6707600159	RLD5-J004A	3787 010 001 0	56	812552001/1E	RLD5-M028	4101 605 001 0	105
6735400445		3774 004 018 0	1	81289010017	RLD5-Z089	3725 002 001 0	89
6735400545		3774 004 019 0	1	81289010018	RLD5-Z089	3725 002 001 0	89
6735400645		3774 004 020 0	1	81289020004	RLD5-Z089	3725 002 001 0	89
6735400745		3774 004 021 0	1	81326200039	RLD5-Z125	1705 517 001 0	92
6820	RLD5-C105	5205 048 001 0	18	81326200043	RLD5-Z125	1705 517 001 0	92
69200580074	RLD5-K076	3735 054 001 0	63	81326200049	RLD5-Z124	1705 516 001 0	92
6EK001559001	RLD5-D011	3736 006 001 0	26	81326200083	RLD5-Z126	1705 518 001 0	93
6EK001559-007	RLD5-D011	3736 006 001 0	26	81326200085	RLD5-Z125	1705 517 001 0	92
6HF001579011	RLD5-L003	3792 501 002 0	66	81326200095	RLD5-Z127	1705 519 001 0	93
6HF002372051	RLD5-L001	3792 507 002 0	66	81501924	RLD5-A045	3774 027 001 0	5
70351744	RLD5-A121	3774 022 002 0	8	81521606020	RLD5-R061	3754 055 001 0	80

INDEX BY ORIGINAL NUMBERS

Cross Ref.	SORL No.	Drawing No.	Page	Cross Ref.	SORL No.	Drawing No.	Page
8155750	RLD5-A030	3774 041 005 0	4	A7315	RLD5-Z137	1705 529 001 0	94
81619670011	RLD5-R023	3756 026 001 0	76	A7318	RLD5-Z136	1705 528 001 0	94
81619670016	RLD5-R023	3754 026 001 0	76	AER2907AER3002	RLD5-N017	3702 002 001 0	68
81619676022	RLD5-R023	3755 026 001 0	76	AZ79100710008	RLD5-R018	3754 023 001 0	76
8189632	RLD5-C211B	5205 514 003 0	21	AZ9100589040	RLD5-Z055	4101 102 001 0	88
81970106011	RLD5-Z082	1705 501 001 0	90	B-193697	RLD5-D012	3736 009 001 0	26
81971006034	RLD5-E008	3704 202 003 0	28	BE13250	RLD5-Z109	4101 056 001 0	105
81980-22040	RLD5-K043	3766 034 001 0	60	CV11	RLD5-B053	3741 008 006 0	12
81980-22060	RLD5-K043	3766 034 001 0	60	D240A	RLD5-D018	3736 008 001 0	24
81980-22070	RLD5-K043	3766 034 001 0	60	DF254	RLD5-R012	3754 029 001 0	75
81980-36010	RLD5-K043	3766 034 001 0	60	DF257A	RLD5-R075	3754 003 012 0	81
81980-36040	RLD5-K043	3766 034 001 0	60	DF261	RLD5-R015	3754 011 001 0	75
81980-36060	RLD5-K043	3766 034 001 0	60	DL124G	RLD5-P005	3721 004 001 0	69
820.000.000	RLD5-D022	3703 002 001 0	26	DL124G	RLD5-P012	3721 005 001 0	70
854300894300	RLD5-B001	3741 055 001 0	9	DL125G	RLD5-P009	3721 001 002 0	69
88.25503.0062	RLD5-L001	3792 507 002 0	66	DL137G/D	RLD5-P059	3721 009 001 0	71
89422-20010	6499 3590	3808 306 001 0	100	DL32GD	RLD5-P004	3721 301 003 0	70
8JA003831001	RLD5-F003	3730 004 001 0	31	DL32H-12	RLD5-P004B	3721 301 002 0	70
8JB003833001	RLD5-F003	3730 004 001 0	31	DL32H-24	RLD5-P004D	3721 301 004 0	70
90816130129	RLD5-E012	3704 002 004 0	29	DL32L-12	RLD5-P004A	3721 301 001 0	70
91715P	RLD5-A008	3774 012 002 0	2	DL32L-24	RLD5-P004C	3721 301 007 0	70
93360-V3860	RLD5-I055-02	3792 505 005 0	52	DL34G	RLD5-P021	3721 008 001 0	71
93375-V1030	RLD5-I054-03	4102 002 001 0	52	DL34G/D	RLD5-P020	3721 302 001 0	71
93375-V3310	RLD5-I055-01	3792 505 001 0	52	DL50B	RLD5-P014	3721 006 001 0	70
93620-V1030	RLD5-I054-04	4102 003 001 0	52	DL50D	RLD5-P008	3721 002 003 0	69
93662-Y4010G	RLD5-I053-01	3792 020 005 0	52	E4420001031	RLD5-R053	3754 012 037 0	79
93710-V1030	RLD5-I054-05	4102 004 001 0	52	E9341915061	RLD5-D008	3736 007 001 0	25
93727-Y4010G	RLD5-I053-02	3792 020 001 0	52	E9362930012	RLD5-C020	5205 002 001 0	15
93730-V1030	RLD5-I054-02	4102 001 002 0	52	E9362939030	RLD5-A050	3774 011 001 0	6
93740-V1030	RLD5-I054-01	4102 001 001 0	52	E9366939090	RLD5-A051	3774 015 001 0	6
93761-Y4010G	RLD5-I053-05	3792 020 002 0	52	E9402850447	RLD5-C019	5205 043 001 0	15
93762-7A000	RLD5-I053-06	3792 020 006 0	52	EF0212	RLD5-K029	3766 012 002 0	59
93762-Y4010G	RLD5-I053-04	3792 020 004 0	52	EF0212H	RLD5-K031	3766 015 001 0	59
93763-7A000	RLD5-I053-03	3792 020 003 0	52	EF0212L	RLD5-K037	3766 016 001 0	59
9472128908	RLD5-R053	3754 012 037 0	79	EF0216	RLD5-K034	3766 014 001 0	59
960829	RLD5-E006	3704 009 001 0	28	EF0220	RLD5-K035	3766 014 002 0	59
960959877	RLD5-K068	3735 021 001 0	62	EF0312	RLD5-K028	3766 012 001 0	59
98900-45001	RLD5-B022	3746 005 004 0	14	EF0312H	RLD5-K032	3766 015 002 0	59
98900-7300	RLD5-B023	3746 005 001 0	14	EF0312L	RLD5-K036	3766 016 002 0	59
99100760100	RLD5-D002	3703 001 001 0	25	EF0316	RLD5-K030	3766 013 001 0	59
99707005851	RLD5-R050	3754 012 052 0	78	EF0320	RLD5-K033	3766 013 002 0	59
A0005459508	6499 2519	3818 009 003 0	106	F37A-3N823-AA	RLD5-Z033	4101 211 001 0	87
A0011522410	RLD5-H001	3735 049 001 0	37	Foom145307	RLD5-P058	3798 001 002 0	73
A0011523210	RLD5-H002	3735 050 001 0	37	FT00101KS01	RLD5-E013	3704 011 001 0	29
A0015455809	RLD5-M013	4101 006 001 0	104	G0173020011A0		1705 002 012 0	95
A0018302184	RLD5-R023	3758 026 001 0	76	G0173020030A0		1705 502 015 0	95
A0028302784	RLD5-R023	3757 026 001 0	76	G0173020039A0		1705 502 018 0	95
A0035452013	RLD5-I058	3746 001 002 0	42	G0173020043A0		1705 502 016 0	95
A0035455113	RLD5-I059	3746 001 001 0	43	G0173020045A0		1705 502 017 0	95
A0045450113	RLD5-I082	3746 001 004 0	44	G0173020051A0		1705 502 021 0	95
A0045450224	RLD5-L001	3792 507 002 0	66	G0173020060A0		1705 002 023 0	96
A0045454713	RLD5-I081	3746 001 003 0	44	GFD1090P4K	RLD5-R091	3754 002 012 0	83
A0075453624	RLD5-A045	3774 027 001 0	5	GM9324822900	RLD5-R098	3754 006 001 0	84
A0135426717	6499 4611	3802 601 001 0	102	H07C	RLD5-A054	3774 009 002 0	6
A4487	RLD5-Z104	1705 503 001 0	91	H07C	RLD5-A055	3774 009 001 0	6
A4900	RLD5-Z128	1705 520 001 0	93	H-7B000S	RLD5-R029	3754 035 001 0	76
A5010	RLD5-Z129	1705 521 001 0	93	HLS202.345	RLD5-A058	3774 006 005 0	6
A6555450008	6499 2231	3818 009 001 0	106	HLS203743	RLD5-A056	3774 013 003 0	6
A6675450013	6499 2418	3818 009 002 0	106	IZ0040WL01	RLD5-C032	5205 012 001 0	16
A6909	RLD5-Z110	1705 502 013 0	91	IZ0080WL01	RLD5-C033	5205 003 001 0	16
A6910	RLD5-Z111	1705 502 014 0	91	JD2912	RLD5-K021A	3735 033 001 0	64
A6918	RLD5-Z132	1705 524 001 0	93	JD2912	RLD5-K023A	3735 036 001 0	65
A-6918	RLD5-Z135	1705 502 032 0	94	JD2912	RLD5-K041	3766 032 001 0	66
A7313	RLD5-Z138	1705 530 001 0	94	JD2914	RLD5-K020A	3735 033 001 0	64

INDEX BY ORIGINAL NUMBERS

Cross Ref.	SORL No.	Drawing No.	Page				
JD2914	RLD5-K024	3735 037 001 0	65				
JK611	RLD5-M018	4101 037 001 0	105				
LS20099	RLD5-A052	3774 028 001 0	5				
M0009974036	RLD5-R061	3754 055 001 0	80				
MC-843788	RLD5-K044	3766 035 001 0	65				
MI0090WL01	RLD5-C082	5205 020 001 0	17				
MI0100WL01	RLD5-C084	5205 019 001 0	17				
MZ0040ML01	RLD5-C085	5205 022 001 0	17				
MZ0130WL01	RLD5-C080	5205 025 001 0	17				
MZ0150ML01	RLD5-C087	5205 023 001 0	17				
MZ035WL01	RLD5-C081	5205 024 001 0	17				
NN0100WL01	RLD5-C034	5205 010 001 0	16				
NN0310WL01	RLD5-C036	5205 009 001 0	16				
NN0320WL01	RLD5-C030	5205 004 001 0	16				
NN0390WL01	RLD5-C088	5205 021 001 0	17				
NN03F0WL01	RLD5-C089	5205 026 001 0	17				
O302319	RLD5-E012	3704 002 004 0	29				
OK43F55475	RLD5-Z140	3802 120 001 0	103				
OK72A5495A	RLD5-Z140	3802 120 001 0	103				
RL3516LAAE4	RLD5-R042	3754 038 001 0	78				
RZ28QK	RLD5-M048	3757 001 001 0	107				
RZPF313A	RLD5-R017	3754 010 001 0	75				
SG254B	RLD5-K049	3766 026 001 0	60				
SG254C	RLD5-K050A	3766 026 004 0	61				
SL1009EL	RLD5-G020	3722 004 002 0	35				
SL1009EL	RLD5-G023	3722 010 001 0	35				
TA0080DB01	RLD5-G027	3722 006 001 0	36				
TA0080KS02	RLD5-E024	3704 012 002 0	28				
TA00F0WL01	RLD5-C083	5205 028 001 0	17				
TA0100KS01	RLD5-E016	3704 012 001 0	29				
TA0200WL01	RLD5-C026	5205 005 001 0	16				
TA0260WL01	RLD5-C086	5205 027 001 0	17				
TA0360DB00	RLD5-G019	3722 001 001 0	35				
TA0360WL01	RLD5-C037	5205 014 001 0	16				
TA0400WL01	RLD5-C031	5205 011 001 0	16				
TA0530WL01	RLD5-C035	5205 013 001 0	17				
TA0540WL01	RLD5-C029	5205 008 001 0	16				
TA0600DB00	RLD5-G021	3722 005 002 0	35				
VB2502802	RLD5-A024	3774 020 001 0	4				
VF-102	RLD5-R022	3754 013 001 0	76				
WA13240	6499 2621	3818 017 001 0	104				
WA13241	6499 2622	3818 018 001 0	105				
WA13255	6499 2620	3818 016 001 0	104				
WG9100270065	RLD5-P038	3798 002 013 0	72				
WG9130583117/1	RLD5-A124	3774 013 020 0	8				
WG9725764001	RLD5-D028	3703 003 002 0	27				
WG9925580102	RLD5-A122	3774 013 021 0	8				
YC444K072AA	RLD5-R050	3754 012 052 0	78				
ZK6739.1550	RLD5-C106	5205 049 001 0	18				
	RLD5-J005	3787 009 001 0	56				



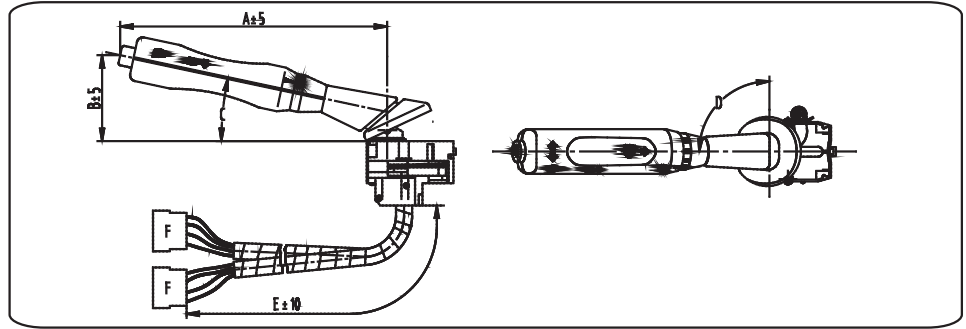





SORL	Drawing	Cross	L/R	Knob Length	AngleC	AngleF	Cable Length	Plug	Automatic Return
RLD5-A001	3774 004 001 0	620 540 00 45	LHD	206	21.5°C	102°C	800	B	Available
RLD5-A002	3774 004 002 0	620 540 01 45	RHD	206	21.5°C	78°C	800	B	Available
RLD5-A003	3774 004 003 0	655 540 01 45	RHD	206	21.5°C	78°C	650	C	Available
RLD5-A004	3774 004 004 0	655 540 00 45	LHD	206	21.5°C	102°C	650	C	Available
RLD5-A005	3774 004 005 0	357 540 00 45	LHD	195	10°C	102°C	485	A	Available
RLD5-A006	3774 004 006 0	357 540 01 45	RHD	195	10°C	78°C	485	A	Available
RLD5-A130	3774 004 012 0	357 540 02 45	LHD	195	10°C	102°C	485	A	
RLD5-A131	3774 004 013 0	357 540 03 45	RHD	195	10°C	78°C	485	A	
RLD5-A132	3774 004 014 0	673 540 01 45	LHD	200	25°C	90°C	380	A	Available
RLD5-A133	3774 004 015 0	673 540 02 45	RHD	200	25°C	90°C	430	A	Available
RLD5-A134	3774 004 016 0	343 540 00 45	LHD	200	25°C	90°C	650	B	Available
RLD5-A135	3774 004 017 0	376 540 01 45	LHD	200	25°C	90°C	380	A	Available
RLD5-A136	3774 004 018 0	673 540 04 45	LHD	187.5	26.5°C	90°C	380	A	Available
RLD5-A137	3774 004 019 0	673 540 05 45	RHD	187.5	26.5°C	90°C	430	A	Available
RLD5-A138	3774 004 020 0	673 540 06 45	LHD	187.5	26.5°C	90°C	480	A	Available
RLD5-A139	3774 004 021 0	673 540 07 45	RHD	187.5	26.5°C	90°C	530	A	Available
RLD5-A140	3774 004 022 0	655 540 04 45	LHD	181	24°C	102°C	650	C	Available
RLD5-A141	3774 004 023 0	655 540 05 45	RHD	181	24°C	78°C	650	C	Available
RLD5-A142	3774 004 024 0	425 540 00 45	LHD	187.5	21°C	74°C	270	A	Available
RLD5-A143	3774 004 025 0	437 540 00 45	LHD	187.5	21°C	66°C	420	C	Available
RLD5-A144	3774 004 026 0	437 540 01 45	RHD	187.5	21°C	90°C	420	C	Available
RLD5-A145	3774 004 027 0	357 540 10 45	LHD	209	10°C	90°C	485	A	Available







Plug A





Plug B

Plug C





Combination Switch	
	<p>RLD5-A007</p> <p>Drawing: 3774 012 001 0 Drive: Left-hand Cable Length: 530mm Pins: 15</p> <p>Cross 0055451024 0055453824 0045454224 0055455124 SWF 201918</p> <p>Application Mercedes Truck 917402LP</p>
	<p>RLD5-A008</p> <p>Drawing: 3774 012 002 0 Drive: Right -hand Cable Length: 530mm Mounting Hole: Φ45 Pins: 15</p> <p>Cross 0055455224 0045455324 0045451124 0045453924 SWF 91715P</p> <p>Application Mercedes Truck 9174022P Mecerdes Truck 917, NG</p>
	<p>RLD5-A009</p> <p>Drawing: 3774 012 003 0 Mounting Hole: Φ45 Lever Length: 170mm Cable Length: 530mm Pins: 13</p> <p>Cross 0045458124</p> <p>Application Mercedes Truck 917</p>
	<p>RLD5-A010</p> <p>Drawing: 3774 013 002 0 Drive: Left-hand Cable Length: 690mm Pins: 16</p> <p>Cross 81.25509.0093 81.25509.0124 81.25509.0028 81.25509.0119 SWF202356</p> <p>Application MAN</p>





	<p>RLD5-A011</p> <p>Drawing: 3774 013 001 0 Drive: Left-hand Cable Length: 690mm Voltage: 24V Pins: 15</p> <p>Cross 81.25509.9724</p> <p>Application STW MAN F2000 Truck</p>
	<p>RLD5-A012</p> <p>Drawing: 3774 024 001 0 Drive: Left-hand Cable Length: 690mm Voltage: 24V Pins: 15</p> <p>Cross 0085450124</p> <p>Application HLS202850 Mercedes(Atego & Actros)</p>
	<p>RLD5-A013</p> <p>Drawing: 3774 012 004 0 Drive: Left-hand Cable Length: 350mm Pins: 13</p> <p>Cross 0065457824</p> <p>Application Mercedes 207 W207, 208, 210, 310</p>
	<p>RLD5-A014</p> <p>Drawing: 3774 044 001 0 Drive: Left-hand Cable Length: 480mm Lever Length: 140mm Pins: 10</p> <p>Cross 0035458724</p> <p>Application Mercedes 10P</p>





Combination Switch	
RLD5-A015	
	Drawing: 3774 044 002 0 Drive: Left-hand Cable Length: 480mm Lever Length: 210mm Handle: 21cm
Cross	0035458324 0035458124
Application	Mercedes 207 Mercedes Bus 911
RLD5-A016	
	Drawing: 3774 006 024 0 Cable Length: 490mm Mounting Hole: $\Phi 45$ Pins: 14
Cross	7332017000
Application	Mercedes
RLD5-A017	
	Drawing: 3774 006 001 0 Drive: Left-hand Mounting Hole: $\Phi 55$ Pins: 14
Cross	79100580346 SWF201259
Application	MAN, Steyr truck
RLD5-A018	
	Drawing: 3774 003 001 0 Drive: Left-hand Mounting Hole: $\Phi 30$
Application	Dong Feng EQ153&145 Nissan





RLD5-A019	
	Drawing: 3774 048 001 0 Cable Length: 250mm Pins: 5
Cross	1594959-1 201563
Application	Volvo F7, F10, F12,F16
RLD5-A020	
	Drawing: 3774 048 002 0 Cable Length: 400mm Pins: 5
Cross	LS201095
Application	Volvo TD100
RLD5-A021	
	Drawing: 3774 019 001 0 Cable Length: 400mm Model: 112mm Pins: 8
Cross	367326, 0301491 0347893, 0367326
Application	Scania T93, T113, T143
RLD5-A022	
	Drawing: 3774 022 001 0 Drive: Left-hand Cable Length: 100mm Pins: 13
Cross	20797836, SWF 203.102 1096413, 3172171
Application	Volvo B7'S&B9'S Volvo FH12,FH16,FM





Combination Switch	
	<p>RLD5-A022B</p> <p>Drawing: 3774 022 002 0 Drive: Left-hand Cable Length: 100mm</p> <p>Cross 3172170 Application Volvo</p>
	<p>RLD5-A023</p> <p>Drawing: 3774 021 001 0 Cable Length: 400mm Pins: 9</p> <p>Cross 360247 SWF 201726 Application Scania 113, 143</p>
	<p>RLD5-A024</p> <p>Drawing: 3774 020 001 0 Cable Length: 400mm Pins: 8</p> <p>Cross VB2502802 360248 Application Scania 113,3 Series T93T143</p>
	<p>RLD5-A026</p> <p>Drawing: 3774 017 001 0 Cable Length: 330mm Pins: 10</p> <p>Cross 251291 Application Renault</p>





	<p>RLD5-A028</p> <p>Drawing: 3774 046 001 0 Pins: 5</p>
	<p>RLD5-A028A</p> <p>Drawing: 3774 046 002 0 Pins: 6</p> <p>Application JN162</p>
	<p>RLD5-A029</p> <p>Drawing: 3774 002 001 0 Pins: 23</p> <p>Cross JK319 3709010-50 Application CA151 Hongyan</p>
	<p>RLD5-A030</p> <p>Drawing: 3774 041 005 0 Drive: Left-hand Pins: 7</p> <p>Cross 8155750 1578073 1587058 1594958 Application Volvo Truck & Bus Kamaz</p>
	<p>RLD5-A033</p> <p>Drawing: 3774 049 001 0 Pins: 10</p> <p>Cross 083865039 003545832 Application Mercedes</p>



Combination Switch	
 <p>RLD5-A034 Drawing: 3774 050 001 0 Cable Length: 400mm Pins: 6</p> <p>Cross SWF 201094 Application SWF 201094, Volvo, TD100</p>	
 <p>RLD5-A037 Drawing: 3774 025 001 0 Pins: 5</p> <p>Cross 252490 Application Scania Model 111</p>	
 <p>RLD5-A041 Drawing: 3774 020 002 0 Cable Length: 600mm Lever Length: 165mm Pins: 8</p> <p>Cross 81255090020 SWF 202024 Application MAN NM152 F2000</p>	
 <p>RLD5-A042 Drawing: 3774 006 003 0 Mounting Hole: Φ45 Pins: 15</p> <p>Application DAF</p>	





 <p>RLD5-A044 Drawing: 3774 026 001 0 Pins: 8</p> <p>Cross 81.25509.0013 01913200 Application MAN</p>	
 <p>RLD5-A045 Drawing: 3774 027 001 0 Pins: 10</p> <p>Cross A0075453624 81501924 SWF 202641 Application Mercedes</p>	
 <p>RLD5-A052 Drawing: 3774 028 001 0 Pins: 8</p> <p>Cross 297.840 LS20099 SWF 200994 LHD 3645457624 Application Mercedes</p>	
 <p>RLD5-A053 Drawing: 3774 025 002 0 Pins: 7</p> <p>Cross 252491 Application Scania 111</p>	



Combination Switch	
	RLD5-A054 Drawing: 3774 009 002 0 Pins: 15
Cross	H07C
Application	RIYE Hino Truck
	RLD5-A055 Drawing: 3774 009 001 0 Drive: Left-hand Pins: 13
Cross	H07C
Application	RIYE Hino Truck H07C
	RLD5-A055-A Drawing: 3774 009 003 0 Drive: Right-hand Pins: 13
Application	RIYE Hino
	RLD5-A056 Drawing: 3774 013 003 0 Pins: 15
Cross	HLS203743

	RLD5-A060 Drawing: 3774 004 007 0 Cable Length: 800mm Pins: 15
Application	Mercedes
	RLD5-A061 Drawing: 3774 013 004 0 Pins: 14
	RLD5-A072 Drawing: 3774 039 001 0 Pins: 9
Cross	1615081 1440217
Application	DAF Mecerdes
	RLD5-A073 Drawing: 3774 012 005 0 Drive: Left-hand Pins: 15
Application	Sony IkarusBus
	RLD5-A075 Drawing: 3774 013 007 0 Pins: 8
Cross	413000021
Application	LG13-ZHK

Combination Switch	
RLD5-A081	
	Drawing: 3774 002 004 0 Drive: Left-hand Pins: 12
Cross	3735010-240
Application	240 FAW
RLD5-A105	
	Drawing: 3774 051 001 0 Drive: Right -hand Pins: 25
Cross	2845 5450 0143
Application	TATA Winger
RLD5-A106	
	Drawing: 3774 052 001 0 Drive: Right -hand Pins: 19
Cross	5511 5450 0102
Application	TATA Victa
RLD5-A107	
	Drawing: 3774 053 002 0 Drive: Left-hand Pins: 19
Cross	2896 5450 9907
Application	TATA XeNon
RLD5-A108	
	Drawing: 3774 054 001 0 Drive: Right-hand
Cross	2830 5450 9909
Application	TATA 207DI

RLD5-A108A	
	Drawing: 3774 054 002 0 Drive: Left-hand Pins: 19
Cross	2830 5450 9911
Application	TATA Telcoline
RLD5-A109	
	Drawing: 3774 002 010 0 Drive: Right-hand Pins: 6
Application	Mitsubishi
RLD5-A110	
	Drawing: 3774 055 001 0 Drive: Right-hand Pins: 19
Cross	2702 5450 9976
Application	TATA Indica
RLD5-A111	
	Drawing: 3774 057 001 0 Drive: Right-hand Pins: 19
Cross	2843 5450 0101
Application	TATA Indigo

Combination Switch	
RLD5-A112	
	Drawing: 3774 058 001 0 Drive: Right-hand Pins: 22
Cross	2821 5450 0102
Application	TATA 407LPK
RLD5-A119	
	Drawing: 3774 013 010 0 Pins: 3
Cross	JK802A
RLD5-A120	
	Drawing: 3774 002 012 0 Drive: Left-hand Pins: 15
Cross	3735010EA01, D
Application	FAW J6
RLD5-A121	
	Drawing: 3774 022 003 0 Pins: 14
Cross	70351744
Application	Volvo FM&FH

RLD5-A122	
	Drawing: 3774 013 021 0 Pins: 9
Cross	WG9925580102
Application	Howo A7 Styer Styer(wang) Dong Feng Faw Jie Fang
RLD5-A124	
	Drawing: 3774 013 023 0 Pins: 15
Cross	WG9130583117, 1
Application	New Howo
RLD5-A126	
	Drawing: 3774 004 009 0 Drive: Left-hand Pins: 15
Cross	571 545 0124
Application	Mercedes
RLD5-A126A	
	Drawing: 3774 004 010 0 Drive: Right-hand Pins: 15
Cross	571 545 0224
Application	Mercedes





Alternator	
	RLD5-B001 Drawing: 3741 055 001 0
Cross	854300894300 51261017201 51261019201 0091540702 0120469982 1020469686
Application	DAF MAN
	RLD5-B002 Drawing: 3741 056 001 0
Cross	6002026 51261017148 005 15451 02 0120489728
Application	Liebherr MAN Mercedes 355, 402, 352

Water Pump Motor	
	RLD5-B003 Drawing: 3741 010 001 0
Cross	81.26485.6030
Application	MAN Mercedes
	RLD5-B012 Drawing: 3741 012 001 0 Voltage: 24V
Cross	0008693121 1585878
Application	Mercedes Volvo

	RLD5-B015 Drawing: 3741 011 001 0 Voltage: 12V
Cross	008601226 0008693621 008603226 9665345 0665345 81.26485-6016 00000000295970
Application	Mercedes, Scania Iveco, MAN, DAF

Wiper Motor	
	RLD5-B004 Drawing: 3741 009 002 0 Voltage: 24V Mounting Hole: Φ 72, 3-M6x1-15 Connecting Shaft: Φ 9.3 Straight tooth
Cross	0018241501
Application	HLS202850 Mercedes Atego & Actros
	RLD5-B005 Drawing: 3741 009 001 0 Voltage: 24V Mounting Hole: Φ 72, 3-M6x1-15 Connecting Shaft: Δ 1: 3, M8x1.25 Tooth: Bevel gear
Cross	001 824 1501 3818240301 3818244810
Application	Mercedes
	RLD5-B006 Drawing: 3741 003 001 0 Voltage: 24V Mounting Hole: Φ 72, 3-M6x1-15 Connecting Shaft: Φ 9.3 Straight tooth
Cross	406629, SWF 402308, SWF 403071 SWF 403873, SWF 407071 0048206742, 0038205042 0028203042, 0038202742
Application	Mercedes, Scania

Wiper Motor	
	<p>RLD5-B008</p> <p>Drawing: 3741 003 002 0 Voltage: 24V Mounting Hole: Φ72, 3-M6x1-15 Connecting Shaft: Φ13 Straight tooth</p> <p>Cross 81.26401.6134 Application MAN F90 F2000 TGA</p>
	<p>RLD5-B010</p> <p>Drawing: 3741 045 001 0 Voltage: 24V Connecting Shaft: Φ9.3 Straight tooth</p> <p>Cross 402.110,24 000 824 4401 Application Mercedes</p>
	<p>RLD5-B017</p> <p>Drawing: 3741 003 005 0 Voltage: 24V Mounting Hole: Φ72, 3-M6x1-15 Connecting Shaft: Φ9.3 Straight tooth</p> <p>Application Mercedes</p>
	<p>RLD5-B018</p> <p>Drawing: 3741 008 001 0 Voltage: 24V Mounting Hole: Φ72, 3-M6x1-15 Connecting Shaft: Δ 1: 3M10x1.5</p> <p>Application Volvo, Howo</p>



	<p>RLD5-B019</p> <p>Drawing: 3741 003 006 0 Voltage: 24V Mounting Hole: Φ72, 3-M6x1-15 Connecting Shaft: Φ13 Straight tooth</p> <p>Application Mercedes</p>
	<p>RLD5-B020</p> <p>Drawing: 3741 004 001 0 Voltage: 24V Mounting Hole: Φ70, 3-M6x1-15 Connecting Shaft: Δ 1: 3M8x1.25</p> <p>Application AuMan</p>
	<p>RLD5-B026</p> <p>Drawing: 3741 006 001 0 Voltage: 24V</p> <p>Application EQ153</p>
	<p>RLD5-B027</p> <p>Drawing: 3741 003 007 0 Voltage: 24V Mounting Hole: Φ72, 3-M6x1-15 Connecting Shaft: Δ 1: 3M8x1.25</p> <p>Application Mercedes</p>
	<p>RLD5-B028</p> <p>Drawing: 3741 001 001 0 Voltage: 24V Mounting Hole: Φ72, 3-M6x1-15 Connecting Shaft: Δ 1: 3M8x1.25</p> <p>Application ST, STW</p>

Wiper Motor	
	<p>RLD5-B029</p> <p>Drawing: 3741 050 001 0 Voltage: 24V Mounting Hole: Φ50.8, 3-M6x1-15 Connecting Shaft: Δ 1: 3M8x1.25</p>
	<p>RLD5-B030</p> <p>Drawing: 3741 051 001 0 Voltage: 24V Mounting Hole: Φ64, 3-M6x1-15 Connecting Shaft: Δ 1: 3M8x1.25</p> <p>Application HongYan</p>
	<p>RLD5-B031</p> <p>Drawing: 3741 005 001 0 Voltage: 24V Mounting Hole: Φ70, 3-M6x1-15 Connecting Shaft: Δ 1: 3M8x1.25</p> <p>Application FAW</p>
	<p>RLD5-B032</p> <p>Drawing: 3741 046 001 0 Voltage(V)12 Connecting Shaft: Δ 1: 3M6x1</p> <p>Application Construction Vehicle</p>
	<p>RLD5-B033</p> <p>Drawing: 3741 047 001 0 Voltage: 24V Mounting Hole: 3-M6x1-15 Connecting Shaft: Δ 1: 3M8x1.25</p> <p>Cross 140</p>

	<p>RLD5-B034</p> <p>Drawing: 3741 041 001 0 Voltage: 24V Mounting Hole: Φ50.8, 3-M6x1-15 Connecting Shaft: Δ 1: 3M8x1.25</p>
	<p>RLD5-B037</p> <p>Drawing: 3741 042 001 0 Voltage: 24V</p>
	<p>RLD5-B038</p> <p>Drawing: 3741 043 001 0 Voltage: 24V</p>
	<p>RLD5-B039</p> <p>Drawing: 3741 052 001 0 Voltage: 24V</p> <p>Application Lapras</p>
	<p>RLD5-B040</p> <p>Drawing: 3741 048 001 0 Voltage: 24V</p> <p>Application Lapras</p>

Wiper Motor	
	<p>RLD5-B041 Drawing: 3741 049 001 0 Voltage: 24V</p>
	<p>RLD5-B046 Drawing: 3744 009 001 0 Voltage: 24V</p>
	<p>RLD5-B047 Drawing: 3741 008 004 0 Voltage: 24V</p> <p>Application Howo</p>
	<p>RLD5-B048 Drawing: 3744 010 001 0 Voltage: 24V</p>
	<p>RLD5-B050 Drawing: 3741 057 001 0 Voltage: 12V</p>
	<p>RLD5-B050A Drawing: 3741 057 002 0 Voltage: 24V</p> <p>Application Hyundai car</p>

	<p>RLD5-B051 Drawing: 3741 059 001 0</p> <p>Application Dong Fong TianLong</p>
	<p>RLD5-B052 Drawing: 3741 003 010 0 Voltage: 24V Mounting Hole: Φ72, 3-M6x1-15 Connecting Shaft: Δ 1: 3 M8x1.25</p> <p>Cross 5188200142 Application North Mercedes H06</p>
	<p>RLD5-B053 Drawing: 3741 008 006 0 Voltage: 24V Mounting Hole: Φ72, 3-M6x1-15 Connecting Shaft: Δ 1: 3 M8x1.25</p> <p>Cross CV11 Application LiFan</p>
	<p>RLD5-B054 Drawing: 3741 050 006 0 Voltage: 24V Mounting Hole: Φ50.8, 3-M6x1-15 Connecting Shaft: Δ 1: 3, M8x1.25</p> <p>Application Li Fan 1860</p>

Wiper Motor	
	RLD5-B055 Drawing: 3741 058 001 0 Voltage: 12V
Cross	8#
Application	Hyundai car
	RLD5-B056 Drawing: 3741 065 001 0 Wiper Motor Voltage: 24V Mounting Hole: $\Phi 72$, M6x1-15 Connecting Shaft: $\Delta 1$: 3M10x1.5
Cross	002 404 233
Application	SWF, Mercedes



Heater-VentMotor	
	RLD5-B009 Drawing: 3744 004 001 0 Voltage: 12V
Application	Renault
	RLD5-B036 Drawing: 3744 005 001 0 Voltage: 24V 220W
Application	FAW CA151



	RLD5-B042 Drawing: 3744 0120010 Voltage: 24V
Cross	ST
	RLD5-B043 Drawing: 3744 0060010 Voltage: 24V
Cross	EQ153
	RLD5-B044 Drawing: 3744 007 001 0 Voltage: 24V
Application	CA141
	RLD5-B045 Drawing: 3744 008 001 0 Voltage: 24V

Window Regulator Motor	
	RLD5-B021 Drawing: 3746 005 003 0 Drive: Left-hand Voltage: 24V Torque: 8.5N.m
Cross	98900-45001





Window Regulator Motor	
	<p>RLD5-B022</p> <p>Drawing: 3746 005 004 0 Drive: Right-hand Voltage: 24V Torque: 8.5N.m</p> <p>Cross 98900-45001</p>
	<p>RLD5-B023</p> <p>Drawing: 3746 005 001 0 Drive: Left-hand Voltage: 24V Torque: 8.5N.m</p> <p>Cross 98900-7300</p>
	<p>RLD5-B024</p> <p>Drawing: 3746 005 002 0 Drive: Right-hand Voltage: 24V Torque: 8.5N.m</p> <p>Cross 98900-7300</p>
	<p>RLD5-B025</p> <p>Drawing: 3746 004 002 0 Drive: Right-hand Voltage: 24V Torque: 8.5N.m</p>
	<p>RLD5-B025A</p> <p>Drawing: 3746 004 001 0 Drive: Lift-Hand Voltage: 24V Torque: 8.5N.m</p>





RLD5-B049	
	<p>Drawing: 3746 0120010</p> <p>Application FAWFAW CA151</p>





Link Assy	
	<p>RLD5-C001</p> <p>Drawing: 5205 037 003 0 Drive: Right-hand Mounting Hole: $\Phi 9.4$ Straight tooth</p> <p>Cross 381.80001 41 381.82003 41</p> <p>Application Mercedes Truck AuMan</p>
	<p>RLD5-C002</p> <p>Drawing: 5205 037 002 0 Drive: Left-hand</p> <p>Cross 381820004 1 381820024 1</p> <p>Application Mercedes Truck</p>
	<p>RLD5-C003</p> <p>Drawing: 5205 039 001 0</p> <p>Application STW</p>





Link Assy	
	<p>RLD5-C004</p> <p>Drawing: 5205 033 001 0 Drive: Left-hand Mounting Hole: $\Phi 13.2$ Straight tooth</p> <p>Cross 81.26411.6089 Application MAN F2000</p>
	<p>RLD5-C005</p> <p>Drawing: 5205 042 001 0</p> <p>Application FAW CA151</p>
	<p>RLD5-C006</p> <p>Drawing: 5205 035 001 0</p> <p>Application FAW CA151</p>
	<p>RLD5-C014</p> <p>Drawing: 5205 031 002 0 Mounting Hole: $\Phi 10.2(S)$ Connecting Shaft: $\Delta 1: 3 M10 \times 1.5$</p> <p>Application Volve Howo</p>
	<p>RLD5-C019</p> <p>Drawing: 5205 043 001 0</p> <p>Cross E9402850447 Application FAW JD</p>

	<p>RLD5-C020</p> <p>Drawing: 5205 002 001 0</p> <p>Cross E936293001 2 Application FAW JD</p>
	<p>RLD5-C024</p> <p>Drawing: 5205 033 002 0 Drive: Right-hand Mounting Hole: $\Phi 13.2$ Straight tooth</p> <p>Cross RHD: 81.26411.6090 Application MAN</p>
	<p>RLD5-C025</p> <p>Drawing: 5205 015 001 0</p>
	<p>RLD5-C026</p> <p>Drawing: 5205 005 001 0</p> <p>Cross TA0200WL01 Application Toyota</p>
	<p>RLD5-C027</p> <p>Drawing: 5205 006 001 0</p> <p>Application Toyota EE90 88</p>





Link Assy	
	RLD5-C028 Drawing: 5205 007 001 0 Cross Application TA0100WL01 Toyota
	RLD5-C029 Drawing: 5205 008 001 0 Cross Application TA0540WL01 Toyota Condor
	RLD5-C030 Drawing: 5205 004 001 0 Cross Application NN0320WL01
	RLD5-C031 Drawing: 5205 011 001 0 Cross Application TA0400WL01 Toyota
	RLD5-C032 Drawing: 5205 012 001 0 Cross Application IZ0040WL01

	RLD5-C033 Drawing: 5205 003 001 0 Cross Application IZ0080WL01
	RLD5-C034 Drawing: 5205 010 001 0 Cross Application NN0100WL01
	RLD5-C035 Drawing: 5205 013 001 0 Cross Application TA0530WL01 Toyota
	RLD5-C036 Drawing: 5205 009 001 0 Cross Application NN0310WL01
	RLD5-C037 Drawing: 5205 014 001 0 Cross Application TA0360WL01 Toyota

Link Assy	
	RLD5-C080 Drawing: 5205 025 001 0
Cross	MZ0130WL01
	RLD5-C081 Drawing: 5205 024 001 0
Cross	MZ035WL01
	RLD5-C082 Drawing: 5205 020 001 0
Cross	MI0090WL01
	RLD5-C083 Drawing: 5205 028 001 0
Cross Application	TA00F0 WL01 Toyota
	RLD5-C084 Drawing: 5205 019 001 0
Cross	MI0100WL01





	RLD5-C085 Drawing: 5205 022 001 0
Cross	MZ0040WL01
	RLD5-C086 Drawing: 5205 027 001 0
Cross Application	TA0260WL01 Toyota
	RLD5-C087 Drawing: 5205 023 001 0
Cross	MZ015WL01
	RLD5-C088 Drawing: 5205 021 001 0
Cross	NN0390WL01
	RLD5-C089 Drawing: 5205 026 001 0
Cross	NN03F0WL01

Link Assy	
	RLD5-C090 Drawing: 5205 029 001 0
	RLD5-C092 Drawing: 5205 001 002 0
Application	ST
	RLD5-C094 Drawing: 5205 034 001 0
Application	Syria
	RLD5-C101 Drawing: 5205 044 001 0
Application	Luxury Bus
	RLD5-C102 Drawing: 5205 045 001 0
Application	Luxury Bus,CMB







	RLD5-C103 Drawing: 5205 046 001 0
Application	Suzhou KingLong LongL-1800
	RLD5-C104 Drawing: 5205 047 001 0
Application	Xiamen KingLong,CMB
	RLD5-C105 Drawing: 5205 048001 0 Length: 750mm
Cross	6820
Application	Yangzhou YaXing
	RLD5-C106 Drawing: 5205 049001 0
Cross	ZK6739.1550
Application	Zhengzhou YuTong







Link Assy	
	RLD5-C107 Drawing: 5205 058 001 0
Application	Dong Feng Tian Jin
	RLD5-C108 Drawing: 5205 057 001 0
Application	Dong Feng Tian Long
	RLD5-C109 Drawing: 5205 059 001 0
Application	FAW J6





Wiper Arm & Blade	
	RLD5-C201 Drawing: 5205 508 001 0 Piece Length: 900mm Drawing: 5205 508 002 0 Piece Length: 1000mm
Application	YuTong
	RLD5-C202 Drawing: 5205 509 001 0 Including Piece: 5205 509 002 0 Drawing: 5205 509 006 0 Including Piece: 5205 509 004 0
	RLD5-C011







	RLD5-C203 Drawing: 5205 509 003 0 Arm Length: 350 Mounting Hole: Δ 1: 3 Small End: Φ 8.2
Cross	023
	RLD5-C009 Drawing: 5205 510 001 0 Including Piece: 5205 509 002 0 Drawing: 5205 510 006 0 Including Piece: 5205 509 004 0
	RLD5-C204 Drawing: 5205 511 001 0 Including Piece: 5205 509 002 0 Drawing: 5205 511 006 0 Including Piece: 5205 509 004 0
	RLD5-C040 Drawing: 5205 509 002 0 Piece Length: 400mm Drawing: 5205 509 004 0 Piece Length: 450mm
	RLD5-C010 Drawing: 5205 511 003 0 Arm Length: Max=430mm(Adjustable) Mounting Hole: Δ 1: 3 Small End: Φ 8.2
Cross	022





Wiper Arm & Blade	
	<p>RLD5-C205</p> <p>Drawing: 5205 512 001 0 Including Piece: 5205 509 002 0 Drawing: 5205 512 006 0 Including Piece: 5205 509 004 0</p>
	<p>RLD5-C012</p> <p>Drawing: 5205 512 003 0 Arm Length: Max=480mm(Adjustable) Mounting Hole: Δ 1:3 Small End: Φ8.2</p> <p>Cross 024</p>
	<p>RLD5-C206</p> <p>Drawing: 5205 504 001 0 (LHD) Drawing: 5205 504 002 0 (RHD)</p>
	<p>RLD5-C042</p> <p>Drawing: 5205 504 004 0 Piece Length: 500mm</p>
	<p>RLD5-C013</p> <p>Drawing: 5205 504 005 0(Left) Drawing: 5205 504 006 0(Right) Mounting Hole: Δ 1:3 Small End: Φ8.2</p> <p>Application ST, STW</p>
	<p>RLD5-C207</p> <p>Drawing: 5205 502 001 0 (LHD) Drawing: 5205 502 002 0 (RHD)</p>







	<p>RLD5-C044</p> <p>Drawing: 5205 502 004 0 Piece Length: 600mm</p> <p>Cross 81.26440.0038 Application MAN</p>
	<p>RLD5-C053</p> <p>Drawing: 5205 502 005 0 (Left) Drawing: 5205 502 013 0 (Right) Mounting Hole: Δ 1: 3 Small End: Φ10.2</p> <p>Cross Left: 81.26430.0113 Right: 81.26430.0083 Application MAN</p>
	<p>RLD5-C208</p> <p>Drawing: 5205 500 001 0 (LHD) Drawing: 5205 500 011 0 (RHD)</p> <p>Application Howo</p>
	<p>RLD5-C047</p> <p>Drawing: 5205 500 002 0 Piece Length: 700mm</p> <p>Application Howo</p>
	<p>RLD5-C047A</p> <p>Drawing: 5205 500 010 0 Piece Length: 650mm</p> <p>Application Howo</p>
	<p>RLD5-C015</p> <p>Drawing: 5205 500 003 0 (Left) Drawing: 5205 500 012 0 (Right) Drawbar-HookWidth: 12 Mounting Hole: Δ 1: 3 Small End: Φ10.2</p> <p>Application Howo</p>





Wiper Arm & Blade	
	<p>RLD5-C209</p> <p>Drawing: 5205 503 001 0 (LHD) Drawing: 5205 503 002 0 (RHD)</p> <p>Application Mercedes Truck</p>
	<p>RLD5-C048</p> <p>Drawing: 5205 506 001 0 Piece Length: 700mm</p> <p>Cross 000 820 7345 Application Mercedes Truck</p>
	<p>RLD5-C022</p> <p>Drawing: 5205 507 001 0 (Left) Drawing: 5205 507 002 0 (Right)</p> <p>Cross Left: 381 824 0228 Right: 381 824 0528 Application Mercedes Truck</p>
	<p>RLD5-C210</p> <p>Drawing: 5205 513 001 0 Arm Length: 700, 750, 800 Small End: $\Phi 8.2$ Mounting Hole: $\Delta 1: 3$</p>
	<p>RLD5-C210A</p> <p>Drawing: 5205 513 002 0 Arm Length: 700, 750, 800 Small End: $\Phi 10.2$ Mounting Hole: $\Delta 1: 3$</p>
	<p>RLD5-C211</p> <p>Drawing: 5205 514 001 0 (LHD) Drawing: 5205 514 005 0 (RHD)</p> <p>Application Volvo</p>





	<p>RLD5-C211A</p> <p>Drawing: 5205 514 002 0 Piece Length: 700mm</p> <p>Application Volvo</p>
	<p>RLD5-C211B</p> <p>Drawing: 5205 514 003 0(Left) Drawing: 5205 514 004 0(Right) Mounting Hole: $\Delta 1: 3$ Small End: $\Phi 10.2$</p> <p>Cross 466 108.914 8189632 Application Volvo</p>
	<p>RLD5-C212</p> <p>Drawing: 5205 515 001 0(Left) Drawing: 5205 515 005 0(Right)</p>
	<p>RLD5-C212A</p> <p>Drawing: 5205 515002 0 Length: 1000mm</p>
	<p>RLD5-C212B</p> <p>Drawing: 5205 515 003 0 (Left) 5205 515 008 0 (Right) Arm Length: 780mm Drawbar-HookWidth: 12 Mounting Hole: $\Delta 1: 3$ Small End: $\Phi 12.2$ Double-poleflatbody</p>





Wiper Arm & Blade	
	<p>RLD5-C212C</p> <p>Drawing: 5205 515 009 0 (Left) 5205 515 004 0 (Right)</p> <p>Arm Length: 780mm Drawbar-HookWidth: 12 Mounting Hole: Δ 1: 3 Small End: Φ10.2 Double-poleflatbody</p>
	<p>RLD5-C213</p> <p>Drawing: 5205 516 001 0</p> <p>Application AuMan</p>
	<p>RLD5-C213A</p> <p>Drawing: 5205 516 002 0 Piece Length: 500mm</p> <p>Application AuMan</p>
	<p>RLD5-C213B</p> <p>Drawing: 5205 516 003 0 (Left) Arm Length: 630mm</p> <p>Application AuMan</p>
	<p>RLD5-C214</p> <p>Drawing: 5205 517 001 0</p> <p>Application AuMan</p>
	<p>RLD5-C214A</p> <p>Drawing: 5205 517 002 0 Piece Length: 550mm</p> <p>Application AuMan</p>

	<p>RLD5-C214B</p> <p>Drawing: 5205 517 003 0 (Left) Arm Length: 600mm</p> <p>Application AuMan</p>
	<p>RLD5-C215</p>
	<p>RLD5-C215A</p> <p>Drawing: 5205 518 002 0 Piece Length: 800mm Drawing: 5205 518 005 0 Piece Length: 900mm Drawing: 5205 518 006 0 Piece Length: 1000mm</p>
	<p>RLD5-C215B</p> <p>Drawing: 5205 518 003 0 (Left) Small End: Φ12.2 Drawing: 5205 518 004 0 (Right) Small End: Φ12.2 Drawing: 5205 518 007 0 (Left) Small End: Φ10 Drawing: 5205 518 008 0 (Right) Small End: Φ10 Arm Length: 600,650,700,750,800 Mounting Hole: Δ 1: 3 York Width: 25mm</p>
	<p>RLD5-C216A</p> <p>Drawing: 5205 519 001 0 Piece Length: 800mm York Width: 25mm</p>

Wiper Arm & Blade	
	<p>RLD5-C216B</p> <p>Drawing: 5205 519 002 0 Piece Length: 900mm York Width: 25mm</p>
	<p>RLD5-C216C</p> <p>Drawing: 5205 519 003 0 Piece Length: 1000mm York Width: 25mm</p>
	<p>RLD5-C216D</p> <p>Drawing: 5205 519 004 0 (Left) Arm Length: 780 Small End: $\Phi 12$ Double-polecircularbody Small End: $\Phi 12$ Mounting Hole: $\Delta 1: 3$</p>
	<p>RLD5-C216E</p> <p>Drawing: 5205 519 005 0 (Right) Arm Length: 780 Small End: $\Phi 12$ Mounting Hole: $\Delta 1: 3$</p>
	<p>RLD5-C217A</p> <p>Drawing: 5205 519 006 0 (Left) Arm Length: 780mm Small End: $\Phi 10$ Double-polecircularbody Mounting Hole: $\Delta 1: 3$</p>
	<p>RLD5-C217B</p> <p>Drawing: 5205 519 007 0 (Right) Arm Length: 780mm Small End: $\Phi 10$ Mounting Hole: $\Delta 1: 3$ Double-polecircularbody</p>





	<p>RLD5-C218A</p> <p>Drawing: 5205 521 001 0 Piece Length: 600mm York Width: 17.5mm</p>
	<p>RLD5-C218B</p> <p>Drawing: 5205 521 002 0 Piece Length: 700mm York Width: 17.5mm</p>
	<p>RLD5-C218C</p> <p>Drawing: 5205 521 003 0 Piece Length: 700mm York Width: 17.5mm</p>
	<p>RLD5-C218D</p> <p>Drawing: 5205 521 004 0 Piece Length: 800mm York Width: 17.5mm</p>
	<p>RLD5-C218E</p> <p>Drawing: 5205 521 005 0 (Left) Small End: $\Phi 12.2$ Drawing: 5205 521 006 0 (Right) Small End: $\Phi 12.2$ Drawing: 5205 521 007 0 (Left) Small End: $\Phi 10$ Drawing: 5205 521 008 0 (Right) Small End: $\Phi 10$ Arm Length: 600, 650, 700, 750, 800mm York Width: 17.5mm</p>

Solenoid Power Switch	
	<p>RLD5-D001</p> <p>Drawing: 3736 001 004 0 Voltage: 24V Maximun Current: 150A</p> <p>Cross 37AD-35010 Application Mitsubishi Camc</p>
	<p>RLD5-D014</p> <p>Drawing: 3736 001 001 0 Voltage: 24V Charge Current: 200A</p> <p>Cross 3736010-Q53 Application FAW DK236A</p>
	<p>RLD5-D015</p> <p>Drawing: 3736 001 002 0 Voltage: 24V Charge Current: 200A</p> <p>Application FAW 240</p>
	<p>RLD5-D016</p> <p>Drawing: 3736 014 001 0 Voltage: 24V Charge Current: 200A</p> <p>Application FAW D78</p>



	<p>RLD5-D017</p> <p>Drawing: 3736 011 001 0 Voltage: 24V Charge Current: 200A</p> <p>Application JAC</p>
	<p>RLD5-D017A</p> <p>Drawing: 3736 011 002 0 Voltage: 12V Charge Current: 200A</p> <p>Application JAC</p>
	<p>RLD5-D018</p> <p>Drawing: 3736 008 001 0 Voltage: 24V Charge Current: 200A</p> <p>Cross D240A</p>
	<p>RLD5-D019</p> <p>Drawing: 3736 013 003 0 Voltage: 24V Charge Current: 200A</p> <p>Application Lifan</p>

Solenoid Power Switch	
	RLD5-D020 Drawing: 3736 012 001 0 Voltage: 24V Charge Current: 100A
Application	Dongfeng EQ153
	RLD5-D021 Drawing: 3736 013 001 0 Voltage: 24V Charge Current: 200A
Application	DK235, YuTong ShengLong



Manual Power Switch	
	RLD5-D002 Drawing: 3703 001 001 0 Voltage: 24V / 12V Maximun Current: 300A
Cross	034130021 99100760100
Application	Steyr MAN Volvo
	RLD5-D003 Drawing: 3703 001 004 0 Voltage: 24V 12V Charge Current: 300A
Cross	3736010-X160
Application	FAW

	RLD5-D006 Drawing: 3703 003 001 0 Voltage: 24V Charge Current: 200A
Cross	RM-05605
Application	MAN
	RLD5-D007 Drawing: 3703 004 001 0 Voltage: 12V Charge Current: 200A
Cross	08010100 341915060
Application	Iveco Universal
	RLD5-D008 Drawing: 3736 007 001 0 Voltage: 24V/ 12V Charge Current: 200A
Cross	E9341 915 061 443 815 432 020 E9341915061 443815432020
Application	Mercedes Truck M12 Tatra Kamoka
	RLD5-D009 Drawing: 3736 006 002 0 Voltage: 24V / 12V Charge Current: 100A
Cross	0341002003 240315 1587698 3987034
Application	Mercedes, Volvo Scania, DAF, Iveco, MAN

Manual Power Switch	
 <p>Cross Application</p>	<p>RLD5-D010</p> <p>Drawing: 3736 015 001 0 Voltage: 24V / 12V Charge Current: 60A</p> <p>02-9432.00 Mercedes, Volvo</p>
 <p>Cross Application</p>	<p>RLD5-D011</p> <p>Drawing: 3736 006 001 0 Charge Current: 100A Voltage: 12V / 24V</p> <p>0005452508 0005458408 621730 6EK001559001 6EK001559-007 JN162</p>
 <p>Cross</p>	<p>RLD5-D012</p> <p>Drawing: 3736 009 001 0 Charge Current: 75A Voltage: 12V / 24V</p> <p>B-193697</p>
 <p>Cross</p>	<p>RLD5-D013</p> <p>Drawing: 3703 001 008 0 Charge Current: 200A Voltage: 12V / 24V</p> <p>3736020-X160A</p>





 <p>Cross Application</p>	<p>RLD5-D022</p> <p>Drawing: 3703 002 001 0 Charge Current: 300 Voltage: 12V / 24V</p> <p>820.000.000 MAN F90, F2000</p>
 <p>Cross Application</p>	<p>RLD5-D023</p> <p>Drawing: 3736 005 001 0 Charge Current: 300A Voltage: 12V / 24V</p>
 <p>Cross Application</p>	<p>RLD5-D024</p> <p>Drawing: 3703 005 001 0 Charge Current: 200A Voltage: 12V / 24V</p> <p>37ZB1-36010 D138</p>
 <p>Cross Application</p>	<p>RLD5-D025</p> <p>Drawing: 3736 007 003 0 Charge Current: 200A Transient current: 2000A Voltage: 12V / 24V</p> <p>FAW</p>
 <p>Cross Application</p>	<p>RLD5-D026</p> <p>Drawing: 3736 006 003 0 Charge Current: 100A Transient current: 2000A Voltage: 12V / 24V</p> <p>21568629 Volvo</p>

Manual Power Switch	
RLD5-D027	
	Drawing: 3703 001 015 0 Voltage Current: 24V Charge Current: 300A
Cross	3736 020-DL02A
RLD5-D028	
	Drawing: 3703 003 002 0 Charge Current: 200A
Cross	WG9725764001
Application	Volvo Howo
RLD5-D029	
	Drawing: 3703 003 003 0 Charge Current: 200A
Application	Delong
RLD5-D008A	
	Drawing: 3736 007 002 0 Voltage: 24V Charge Current: 200A
Cross	443 815 432 020-B
Application	Mercedes M10



Power Source Box	
RLD5-D030	
	Drawing: 3736 017 001 0 Voltage: 24V Charge Current: 200A
Cross	3722080-382
Application	FAW
RLD5-D030A	
	Drawing: 3736 017 003 0 Voltage: 24V Charge Current: 200A
Cross	3722080-50A
Application	FAW

Ignition Switch	
RLD5-E001	
	Drawing: 3704 016 001 0 Voltage: 24V Current: 10A Max=30A
Application	Mitsubishi
RLD5-E002	
	Drawing: 3704 003 001 0 Voltage: 24V
Cross	0014621130 3504607004
Application	Mercedes 1222-3850
RLD5-E003	
	Drawing: 3704 016 003 0 Voltage: 24V
Application	Mitsubishi
RLD5-E024	
	Drawing: 3704 012 002 0
Cross	45020-12-6(TA0080KS02)
Application	Toyota
RLD5-E005	
	Drawing: 3704 010 001 0
Application	Nissan

RLD5-E006	
	Drawing: 3704 009 001 0
Cross	0005453013 960829 130009
Application	Mercedes
RLD5-E007	
	Drawing: 3704 018 001 0
Cross	0342 106 005
Application	Mercedes Bus Bus SWF911
RLD5-E008	
	Drawing: 3704 202 003 0
Cross	361552 MN1247 81971006034 81.46433.6006
Application	MAN
RLD5-E010	
	Drawing: 3704 002 002 0
Cross	057 550 65 1716 022 2 7656 034 0 81255016030 0502877 0005458308 0342309008
Application	Bomag Faun Henschel Man DAF Mercedes Devti Henschel

Ignition Switch	
RLD5-E011	
	Drawing: 3704 002 003 0
Cross	0342309006
Application	Bosch 5EP
RLD5-E012	
	Drawing: 3704 002 004 0
Cross	0342309004, 0342106005 81255016005, 90816130129 3031673, 1716013, O302319 0342106005, 0342106009, 490102 0302238, 0142001, 1139129712 02482029, 90816130129, 0005453013
Application	MAN, Volvo, Faun, Mercedes
RLD5-E015	
	Drawing: 3704 001 001 0
Cross	02910770
Application	STW, MAN
RLD5-E016	
	Drawing: 3704 012 001 0
Cross	45020-12-11(TA0100KS01)
Application	Toyota

RLD5-E017	
	Drawing: 3704 019 001 0
RLD5-E018	
	Drawing: 3704 002 001 0
Cross	59000580048
Application	ST MAN F2000
RLD5-E019	
	Drawing: 3704 017 001 0
Cross	3708010
Application	JN162
RLD5-E025	
	Drawing: 3704 301 001 0
Cross	371910 1.21087
Application	Scania 82, 112, 142, 93, 113, 143

Ignition Switch	
RLD5-E026	
	Drawing: 3704 302001 0
Cross	81255016033
Application	MAN F2000
RLD5-E027	
	Drawing: 3704 300 001 0 Same as RLD5-Z091
Cross	0005458108
Application	Mercedes SPR207, 208, 312, 412, 413, CDI, 308, 410, 609, 814
RLD5-E028	
	Drawing: 3704 401 001 0
Cross	0005455413 4.61015
Application	Mercedes MB
RLD5-E031	
	Drawing: 3704 003 002 0
Cross	6554620030 6504620030 6504622030
Application	Mercedes

RLD5-E033	
	Drawing: 3704 023 001 0
Cross	513000LOT120753
RLD5-E034	
	Drawing: 3704 024 001 0
Cross	3704110-Q435
Application	FAW
RLD5-E035	
	Drawing: 3704 402 001 0

Seven Pin Plug	
	RLD5-F001 Drawing: 3730 009 001 0 Rated Current: 20A
Application	Mercedes
	RLD5-F001A Socket Drawing: 3730 009 002 0
	RLD5-F001B Plug Drawing: 3730 009 003 0
	RLD5-F002 Drawing: 3730 010 001 0 Rated Current: 20A
	RLD5-F002A Socket Drawing: 3730 010 002 0
	RLD5-F002B Plug Drawing: 3730 010 003 0
Application	Mercedes





	RLD5-F003 Drawing: 3730 004 001 0
Cross	0015450626 0065450626 8JB003833001 8JA003831001 1301750
	RLD5-F003A Socket Drawing: 3730 004 002 0
	RLD5-F003B Plug Drawing: 3730 004 003 0
Application	Mercedes DAF SCANIA
	RLD5-F004 Drawing: 3730 001 003 0 Rated Current: 20A Pins: 7
	RLD5-F004A Socket Drawing: 3730 001 004 0



Seven Pin Plug	
	<p>RLD5-F004B</p> <p>Plug Drawing: 3730 011 003 0</p>
Application	Mercedes
	<p>RLD5-F011</p> <p>Drawing: 3730 006 001 0 Voltage: 24V Rated Current: 20A</p>
	<p>RLD5-F011A</p> <p>Drawing: 3730 006 002 0</p>
	<p>RLD5-F011B</p> <p>Drawing: 3730 006 003 0</p>
	<p>RLD5-F018</p> <p>Drawing: 3730 030 001 0</p>



Electric Cable	
	<p>RLD5-F005</p> <p>Drawing: 3730 001 002 0 Coils: 22 Color: Black</p>





	<p>RLD5-F005A</p> <p>Drawing: 3730 023 001 0 Coils: 22 Color: Black</p>
	<p>RLD5-F010</p> <p>Drawing: 3730 017 001 0 Coils: 22 Color: Black</p>
	<p>RLD5-F010A</p> <p>Drawing: 3730 017 002 0 Coils: 22 Color: Black</p>

Air Hose	
	<p>RLD5-F006</p> <p>Drawing: 3730 013 001 0 M16x1.5 Coils: 23</p>
	<p>RLD5-F006A</p> <p>Drawing: 3730 013 002 0 1/2NPT</p>
	<p>RLD5-F006B</p> <p>Drawing: 3730 013 003 0 M22x1.5 Color: Blue</p>





Air Hose	
	<p>RLD5-F007</p> <p>Drawing: 3730 014 001 0 M16x1.5 Coils: 23 Color: Red</p>
	<p>RLD5-F007A</p> <p>Drawing: 3730 014 002 0 1/2NPT</p>
	<p>RLD5-F007B</p> <p>Drawing: 3730 014 003 0 M22x1.5</p>
	<p>RLD5-F008</p> <p>Drawing: 3730 015 001 0 M16x1.5 Coils: 23</p>
	<p>RLD5-F008A</p> <p>Drawing: 3730 015 002 0 1/2NPT</p>
	<p>RLD5-F008B</p> <p>Drawing: 3730 015 003 0 M22x1.5 Color: Yellow</p>
	<p>RLD5-F009</p> <p>Drawing: 3730 016 001 0 M16x1.5</p>



	<p>RLD5-F009A</p> <p>Drawing: 3730 016 002 0 1/2NPT</p>
	<p>RLD5-F009B</p> <p>Drawing: 3730 016 003 0 M22X1.5 Color: Sky-Blue</p>
	<p>RLD5-F012</p> <p>Drawing: 3730 024 001 0 Coils: 17 M22X1.5 Color: Red</p>
	<p>RLD5-F013</p> <p>Drawing: 3730 025 001 0 Coils: 17 M22X1.5 Color: Yellow</p>
	<p>RLD5-F014</p> <p>Drawing: 3730 026 001 0 Double-deck Color: Blue</p>
	<p>RLD5-F015</p> <p>Drawing: 3730 027 001 0 Double-deck Color: Yellow</p>
	<p>RLD5-F016</p> <p>Drawing: 3730 028 001 0 Color: Red</p>



Air Hose	
	<p>RLD5-F017</p> <p>Drawing: 3730 029 001 0 Color: Yellow 20 Lps M16x1.5</p>
	<p>RLD5-F017A</p> <p>Drawing: 3730 029 002 0 Color: Red 20 Lps NPT 1/2</p>
	<p>RLD5-F017B</p> <p>Drawing: 3730 029 003 0 Color: Blue 20 Lps M16x1.5</p>

Fuse Box	
	<p>RLD5-G007</p> <p>Drawing: 3722 002 001 0 Pins: 12</p> <p>Cross: 5005458401 Application: Mercedes</p>
	<p>RLD5-G008</p> <p>Drawing: 3722 002 004 0 Pins: 12</p> <p>Cross: 0005458401 Application: Mercedes</p>
	<p>RLD5-G009</p> <p>Drawing: 3722 002 005 0 Pins: 12</p> <p>Cross: 5005458401 0005458501 Application: Mercedes</p>
	<p>RLD5-G012</p> <p>Drawing: 3722 001 001 0</p> <p>Cross: 25A 79100580021 50A 5005455001 Application: Mercedes</p>





	<p>RLD5-G019</p>
<p>Drawing: 3722 004 001 0 Voltage: 24V</p>	
<p>Application</p>	<p>Toyota Hilux YN55 84-98 TA0360DB00</p>
	<p>RLD5-G020</p>
<p>Drawing: 3722 004 002 0 Voltage: 24V</p>	
<p>Cross</p>	<p>SL 1009EL TA0360DB01</p>
<p>Application</p>	<p>Toyota</p>
	<p>RLD5-G021</p>
<p>Drawing: 3722 005 002 0 Voltage: 24V</p>	
<p>Application</p>	<p>Toyota Zola 84 TA0600DB00</p>
	<p>RLD5-G022</p>
<p>Drawing: 3722 009 001 0 Pins: 8</p>	
<p>Application</p>	<p>Toyota</p>

<p>Fuse Box</p>	
	<p>RLD5-G023</p>
<p>Drawing: 3722 010 001 0</p>	
<p>Cross</p>	<p>SL 1009EL</p>
<p>Application</p>	<p>EL MANAR</p>
	<p>RLD5-G024</p>
<p>Drawing: 3722 011 001 0 Voltage: 24V</p>	
	<p>RLD5-G025</p>
<p>Drawing: 3722 008 001 0 Voltage: 24V</p>	
<p>Cross</p>	<p>179100580024</p>
<p>Application</p>	<p>ST</p>
	<p>RLD5-G026</p>
<p>Drawing: 3722 008 002 0 Voltage: 24V</p>	
<p>Cross</p>	<p>179100580025</p>
<p>Application</p>	<p>ST</p>

RLD5-G027	
	Drawing: 3722 006 001 0 Voltage: 24V
Cross	TA0080DB01
Application	Toyota Corolla EE90 AE92
RLD5-G028	
	Drawing: 3722 013 001 0
Application	FAW
RLD5-G029	
	Drawing: 3722 012 001 0
RLD5-G030	
	Drawing: 3722 007 001 0
Application	FAW

Fuse	
RLD5-G016	
	Drawing: 3722 014 001 0 Current: 5A 10A 15A 20A 25A 30A 5A Cross: 0025450734 7.5A Cross: 0025450834 10A Cross: 0025450934 15A Cross: 0025451034 25A Cross: 0025451234
RLD5-G017	
	Drawing: 3722 015 001 0 Current: 5A 8A 16A 25A

Central Control Module	
RLD5-G031	
	Drawing: 3722 017 008 8 Current: 100A
Application	Mercedes
RLD5-G032	
	Drawing: 3722 017 001 0
Application	Mercedes
RLD5-G033	
	Drawing: 3722 018 001 0
Application	Mercedes
RLD5-G034	
	Drawing: 3722 018 002 0
Application	Mercedes

Jump-start Relay	
	<p>RLD5-H001 Drawing: 3735 049 001 0 Voltage: 24V Same as RLD5-Z060</p> <p>Cross 1337453 A001 1522410</p> <p>Application Mercedes, DAF, MAN</p>
	<p>RLD5-H002 Drawing: 3735 050 001 0 Same as RLD5-Z069</p> <p>Cross A001 1523210</p> <p>Application Mercedes, DT, Bosch</p>
	<p>RLD5-H003 Drawing: 3735 002 001 0 Voltage: 24V Same as RLD5-Z079</p> <p>Application Mitsubishi(New)</p>
	<p>RLD5-H004 Drawing: 3735 039 001 0</p>
	<p>RLD5-H005 Drawing: 3735 040 001 0</p>

	<p>RLD5-H006 Drawing: 3735 041 001 0</p>
	<p>RLD5-H007 Drawing: 3735 042 001 0</p>
	<p>RLD5-H008 Drawing: 3735 043 001 0</p>
	<p>RLD5-H009 Drawing: 3735 044 001 0</p>
	<p>RLD5-H010 Drawing: 3735 045 001 0</p>
	<p>RLD5-H011 Drawing: 3735 046 001 0</p>

Jump-start Relay



RLD5-H012

Drawing: 3735 047 001 0



RLD5-H013

Drawing: 3735 048 001 0

Start-up Warm-up Relay



RLD5-H014

Drawing: 3735 003 001 0
Connecting Plug: DJ7062-6.3-10



RLD5-H015

Drawing: 3735 003 002 0
Connecting Plug: DJ7067-6.3-10



RLD5-H016

Drawing: 3735 003 003 0
Connecting Plug: DJ7067-6.3-10



RLD5-H017

Drawing: 3735 003 004 0
Connecting Plug: DJ7061F-3-20





RLD5-H018

Drawing: 3735 003 005 0
Connecting Plug: DJ7061K-3-10



RLD5-H019

Drawing: 3735 003 006 0
Connecting Plug: DJ7067-6.3-10

Rocker Switch	
 <p>Cross 1578704 Application Volvo F12, FH, FM</p>	<p>RLD5-I001 Drawing: 3792 001 001 0</p>
 <p>Cross 1578702 Application Volvo F12, F10, F16, F7</p>	<p>RLD5-I002 Drawing: 3792 001 002 0</p>
 <p>Cross 1578700-5 Application Volvo F12</p>	<p>RLD5-I003 Drawing: 3792 001 003 0</p>
 <p>Cross 0008209010 Application Mercedes Truck</p>	<p>RLD5-I028 Drawing: 3792 027 001 0</p>



 <p>Cross 1248200110 Application Mercedes Truck SWF 501123</p>	<p>RLD5-I029 Drawing: 3792 019 001 0</p>
 <p>Cross 37AD-68010 Application Mitsubishi Mercedes GLK</p>	<p>RLD5-I030 Drawing: 3792 012 001 0</p>
 <p>Application Mitsubishi Mercedes GLK</p>	<p>RLD5-I031 Drawing: 3792 015 009 0</p>
 <p>Cross 43241 Application Scania</p>	<p>RLD5-I037 Drawing: 3792 010 001 0</p>

Rocker Switch	
 <p>Cross Application</p>	<p>RLD5-I049-01 Drawing: 3792 036 001 0</p> <p>81.25505.6255 MAN</p>
 <p>Cross Application</p>	<p>RLD5-I049-07 Drawing: 3792 036 009 0</p> <p>81.25505.6209 MAN</p>
 <p>Cross Application</p>	<p>RLD5-I049-09 Drawing: 3792 036 011 0</p> <p>81.25505.6378 MAN</p>
 <p>Cross Application</p>	<p>RLD5-I049-03 Drawing: 3792 036 002 0</p> <p>81.25505.6291 MAN</p>

 <p>Cross Application</p>	<p>RLD5-I049-05 Drawing: 3792 036 004 0</p> <p>81.25505.6280 812550562807 MAN</p>
 <p>Cross Application</p>	<p>RLD5-I049-10 Drawing: 3792 036 005 0</p> <p>81.25505.6267 MAN</p>
 <p>Cross Application</p>	<p>RLD5-I049-11 Drawing: 3792 036 010 0</p> <p>81.25505.6300 MAN</p>
 <p>Cross Application</p>	<p>RLD5-I049-06 Drawing: 3792 036 003 0</p> <p>81.25505.6327 MAN</p>

Rocker Switch	
 <p>Cross Application</p>	<p>RLD5-1049-04 Drawing: 3792 036 006 0</p> <p>81.25505.6326 MAN</p>
 <p>Cross Application</p>	<p>RLD5-1049-02 Drawing: 3792 036 007 0</p> <p>81.25505.6302 MAN</p>
 <p>Cross Application</p>	<p>RLD5-1049-08 Drawing: 3792 036 008 0</p> <p>81.25505.6607 MAN</p>
 <p>Cross Application</p>	<p>RLD5-1056 Drawing: 3792 032 001 0 Voltage: 24V</p> <p>353628 Scania</p>

 <p>Cross Application</p>	<p>RLD5-1057 Drawing: 3790 002 002 0</p> <p>0075456407 Mercedes</p>
 <p>Cross Application</p>	<p>RLD5-1075 Drawing: 3792 003 013 0 Voltage: 24V</p> <p>6115400066 Mercedes</p>





Button Switch	
 <p>Cross Application</p>	<p>RLD5-1020 Drawing: 3792 502 001 0</p> <p>37AD-83010 Mitsubishi, CAMC</p>
 <p>Cross Application</p>	<p>RLD5-1025 Drawing: 3792 009 001 0</p> <p>1363131 Scania Model: III</p>





Button Switch	
	RLD5-I034 Drawing: 3792 018 001 0
Cross	37AD-86011
Application	Mitsubishi
	RLD5-I072 Drawing: 3792 047 001 0
Cross	551154500401
Application	TATA Sumo Victa Gx
	RLD5-I074 Drawing: 3792 051 001 0
Cross	284554500145
Application	TATA Winger

Window Winding Switch	
	RLD5-I019 Drawing: 3790 006 001 0
Cross	5145450124
Application	FAW

	RLD5-I032 Drawing: 3790 008 002 0
Cross	37AD-46040
Application	Mercedes GLK
	RLD5-I033 Drawing: 3790 008 001 0
Cross	37AD-46030
Application	Mercedes GLK
	RLD5-I055 Drawing: 3790 002 001 0
Cross	0045450207
Application	Mercedes 901, 902, 903, 904
	RLD5-I058 Drawing: 3746 001 002 0
Cross	A0035452013
Application	Mercedes

Window Winding Switch	
 <p>RLD5-I059 Drawing: 3746 001 001 0 Voltage: 24V</p> <p>Cross A0035455113 Application Mercedes</p>	
 <p>RLD5-I065 Drawing: 3746 010 001 0 Voltage: 24V</p> <p>Cross 10318809 Application Buick</p>	
 <p>RLD5-I066 Drawing: 3792 021 001 0 Voltage: 12V</p> <p>Cross 10221254 Application Buick</p>	
 <p>RLD5-I067 Drawing: 3746 011 001 0 Voltage: 24V</p> <p>Cross 12135165 Application Buick</p>	

 <p>RLD5-I068 Drawing: 3746 012 001 0 Voltage: 24V</p> <p>Cross 15590707 Application Buick</p>	
 <p>RLD5-I069 Drawing: 3790 012 002 0 Voltage: 24V</p> <p>Cross 15590708 Application Buick</p>	
 <p>RLD5-I070 Drawing: 3790 012 003 0 Voltage: 24V</p> <p>Cross 15602610 Application Buick</p>	
 <p>RLD5-I071 Drawing: 4101 608 001 0 Voltage: 24V</p> <p>Cross 25558081 Application Buick</p>	

Window Winding Switch	
	RLD5-I076
	Drawing: 3746 013 001 0
Cross	269954510163
Application	TATA Safair
	RLD5-I077
	Drawing: 3792 014 001 0
Cross	282354500102
Application	TATA Safair EX
	RLD5-I078
	Drawing: 3746 015 001 0
Cross	269954510164
Application	TATA Sumo Victa GX
	RLD5-I081
	Drawing: 3746 001 003 0 KW: 43, 11 Seuffer-nr: A1214-031-04 ZGE: 004
Cross	A0045454713 000947
Application	Mercedes

RLD5-I082	
	Drawing: 3746 001 004 0 KW: 04, 11 Seuffer-nr: A1214-041-02 ZGE: 003
Cross	A0045450113 0065252
Application	Mercedes

Dimmer Switch	
	RLD5-I051
	Drawing: 3792 011 001 0
Cross	81.25907.0225
Application	MAN

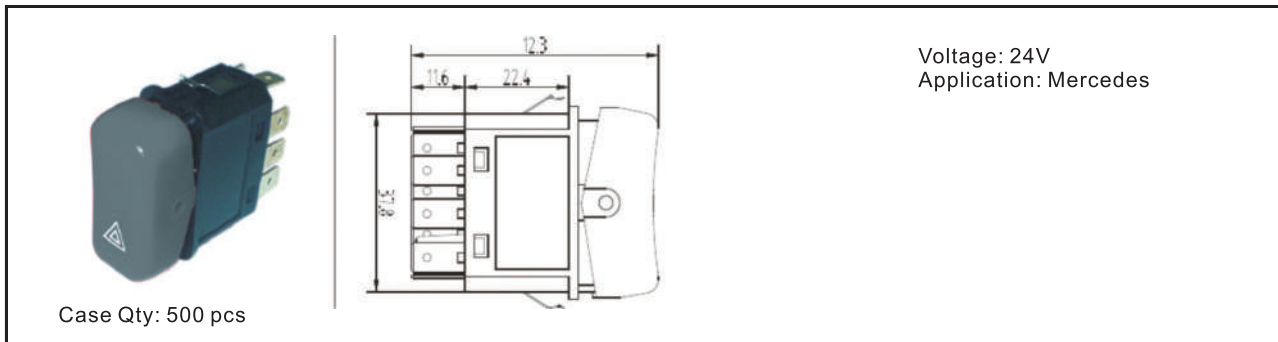

SORL	Flag	Cross	Drawing	Color
RLD5-I007-01		0055459224	3792 003 001 0	Red
RLD5-I007-02	发电	5095459124	3792 003 002 0	Black
RLD5-I007-03		5645459324	3792 003 003 0	Black
RLD5-I007-04	电控 发电机	5115459324	3792 003 004 0	Black
RLD5-I007-05		5115459524	3792 003 005 0	Black
RLD5-I007-06	ASR	5115459624	3792 003 006 0	Black
RLD5-I007-07	定速 巡航	5115459424	3792 003 007 0	Black
RLD5-I007-08	停!	5215459424	3792 003 008 0	Black
RLD5-I007-09	方舱 取电	5865459224	3792 003 009 0	Black
RLD5-I007-10			3792 003 010 0	Black
RLD5-I007-11			3792 003 011 0	Black

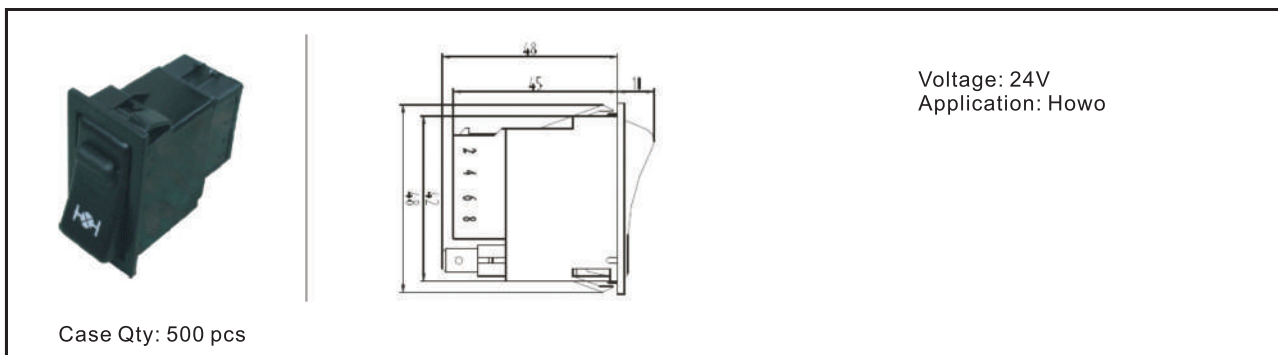

SORL	Flag	Drawing	Wiring Diagram
RLD5-I010-01		3792 006 001 0	
RLD5-I010-02		3792 006 010 0	
RLD5-I010-03		3792 006 009 0	



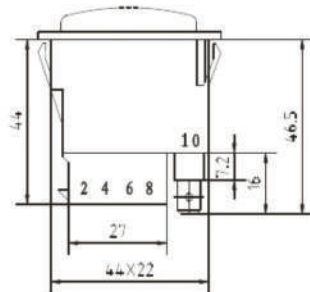



RLD5-I010-04		3792 006 011 0	
RLD5-I010-05		3792 006 002 0	
RLD5-I010-06		3792 006 006 0	
RLD5-I010-07		3792 006 008 0	
RLD5-I010-08		3792 006 005 0	
RLD5-I010-09		3792 006 007 0	
RLD5-I010-10		3792 006 003 0	
RLD5-I010-11		3792 006 004 0	



Voltage: 24V
Application: JK981

Case Qty:500 pcs

SORL	Drawing	Icon	Color
RLD5-I021-01	3792 026 014 0		Green
RLD5-I021-02	3792 026 001 0		Green
RLD5-I021-03	3792 026 002 0		Yellow
RLD5-I021-04	3792 026 004 0		Red
RLD5-I021-05	3792 026 009 0		Green
RLD5-I021-06	3792 026 015 0		Green
RLD5-I021-07	3792 026 012 0		Green
RLD5-I021-08	3792 026 013 0		Green

RLD5-I021-09	3792 026 008 0		Green
RLD5-I021-10	3792 026 003 0		Green
RLD5-I021-11	3792 026 016 0		Green
RLD5-I021-12	3792 026 006 0		Green
RLD5-I021-13	3792 026 017 0		Green
RLD5-I021-14	3792 026 018 0		Green
RLD5-I021-15	3792 026 019 0		Red



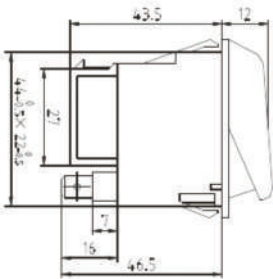

Voltage: 24V
Application:JK991

Case Qty: 500 pcs

SORL	Drawing	Icon	Color
RLD5-I036-01	3792 024 023 0		Green
RLD5-I036-02	3792 024 003 0		Red
RLD5-I036-03	3792 024 024 0		Green
RLD5-I036-04	3792 024 010 0		Green
RLD5-I036-05	3792 024 009 0		Yellow
RLD5-I036-06	3792 024 025 0		Blue
RLD5-I036-07	3792 024 007 0		Green

RLD5-I036-08	3792 024 005 0		Green
RLD5-I036-09	3792 024 002 0		Green
RLD5-I036-10	3792 024 001 0		Red
RLD5-I036-11	3792 024 026 0		Green
RLD5-I036-12	3792 024 027 0		Green
RLD5-I036-13	3792 024 028 0		Green
RLD5-I036-14	3792 024 029 0		Green
RLD5-I036-15	3792 024 030 0		Red
RLD5-I036-16	3792 024 031 0		Green
RLD5-I036-17	3792 024 004 0		Red

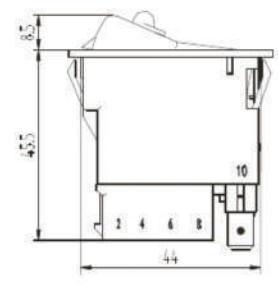



Voltage: 24V
Application: JK931

Case Qty:500 pcs

SORL	Drawing	Icon	Color
RLD5-I052-01	3792 017 001 0		Green
RLD5-I052-02	3792 017 009 0		Green
RLD5-I052-03	3792 017 008 0		Yellow
RLD5-I052-04	3792 017 003 0		Yellow

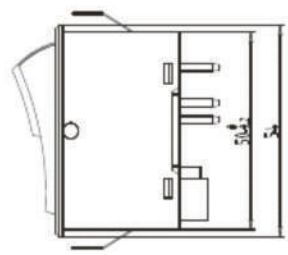







RLD5-I052-05	3792 017 006 0		Green
RLD5-I052-06	3792 017 013 0		Green
RLD5-I052-07	3792 017 014 0		Red
RLD5-I052-08	3792 017 002 0		Yellow
RLD5-I052-09	3792 017 005 0		Red
RLD5-I052-10	3792 017 011 0		Orange
RLD5-I052-11	3792 017 004 0		Red
RLD5-I052-12	3792 017 012 0		Blue
RLD5-I052-13	3792 017 010 0		Red
RLD5-I052-14	3792 017 007 0		Green

Voltage: 24V
Application: ST

Case Qty: 500 pcs

SORL	Drawing	Cross	Icon
RLD5-I056-01	3792 001 007 0	179100580187	
RLD5-I056-02	3792 001 008 0	179100580062	
RLD5-I056-03	3792 001 006 0	179100580076	
RLD5-I056-04	3792 001 009 0	179100580101	

RLD5-I056-05	3792 001 010 0	179100580068	
RLD5-I056-06	3792 001 011 0	179100 5800 67	
RLD5-I056-07	3792 001 012 0	179100580070	
RLD5-I056-08	3792 001 013 0	179100580071	
RLD5-I056-09	3792 001 005 0	179100580060	
RLD5-I056-10	3792 001 004 0	179100580059	
RLD5-I056-11	3792 001 014 0		
RLD5-I056-12	3792 001 015 0		

Case Qty:500 pcs	Case Qty:500 pcs	Case Qty:500 pcs	Case Qty:500 pcs	Case Qty:500 pcs
SORL: RLD5-I004	SORL: RLD5-I005	SORL: RLD5-I006	SORL: RLD5-I039	SORL: RLD5-I042
Drawing: 37920020130	Drawing: 37920020140	Drawing N: 37920020180	Drawing: 37920020100	Drawing: 37920020300
Voltage:24V	Voltage:24V	Voltage:24V	Voltage:24V	Voltage:24V
Rated Current:8A	Rated Current:8A	Rated Current:8A	Rated Current:8A	Rated Current:8A
Cross: 0025452407	Cross: 0025450207	Cross: 0025453207	Cross: 0025454507	Cross: 0025453607
Application: Benz 1459	Application: Benz 1459	Application: Benz 1459	Application: Benz 1459	Application: Benz 1459

SORL	Cross, Drawing	Icon	SORL	Cross, Drawing	Icon
RLD5-I004-01	5215455090 3792 002 033 0		RLD5-I004-14	5115455090 3792 002 042 0	定速 巡航
RLD5-I004-02	3792 002 041 0 520 545 109 0		RLD5-I004-15	5005455490 3792 002 043 0	
RLD5-I004-03	5215455290 3792 002 037 0		RLD5-I004-16	5135450190 3792 002 053 0	
RLD5-I004-04	0085457590 3792 002 032 0		RLD5-I004-17	5005459290 3792 002 051 0	
RLD5-I004-05	0065452990 3792 002 044 0	ABS	RLD5-I004-18	5205450190 3792 002 056 0	
RLD5-I004-06	0035457990 3792 002 030 0		RLD5-I004-19	3792 002 054 0	
RLD5-I004-07	0055458690 3792 002 035 0		RLD5-I004-20	5205450290 3792 002 055 0	
RLD5-I004-08	5215455190 3792 002 036 0		RLD5-I004-21	5205450490 3792 002 057 0	
RLD5-I004-09	3792 002 038 0 520 545 089 0	+ 巡航 -	RLD5-I004-22	5205450590 3792 002 058 0	
RLD5-I004-10	3792 002 039 0	巡航 恢复	RLD5-I004-23	5005429190 3792 002 050 0	A/C
RLD5-I004-11	3792 002 040 0		RLD5-I004-24	5215455390 3792 002 049 0	PTO
RLD5-I004-12	0035459390 3792 002 034 0		RLD5-I004-25	3792 002 045 0 Blue 5095454390 3792 002 047 0 Gree 5095454490 3792 002 048 0 Red 5095454290	
RLD5-I004-13	5005453390 3792 002 031 0				

<p>Case Qty:500 pcs</p>	SORL	Drawing	Cross	Icon
	RLD5-I053-01	3792 020 005 0	93662-Y4010G	
	RLD5-I053-02	3792 020 001 0	93727-Y4010G	
	RLD5-I053-03	3792 020 003 0	93763-7A000	
	RLD5-I053-04	3792 020 004 0	93762-Y4010G	
	RLD5-I053-05	3792 020 002 0	93761-Y4010G	
	RLD5-I053-06	3792 020 006 0	93762-7A000	

<p>Case Qty:200 pcs</p>	SORL	Drawing	Cross	Icon
	RLD5-I054-01	4102 001 001 0	93740-V1030	
	RLD5-I054-02	4102 001 002 0	93730-V1030	
	RLD5-I054-03	4102 002 001 0	93375-V1030	
	RLD5-I054-04	4102 003 001 0	93620-V1030	
	RLD5-I054-05	4102 004 001 0	93710-V1030	

<p>Case Qty:500 pcs</p>	SORL	Drawing	Cross	Icon
	RLD5-I055-01	37925050010	93375-V3310	
	RLD5-I055-02	37925050050	93360-V3860	

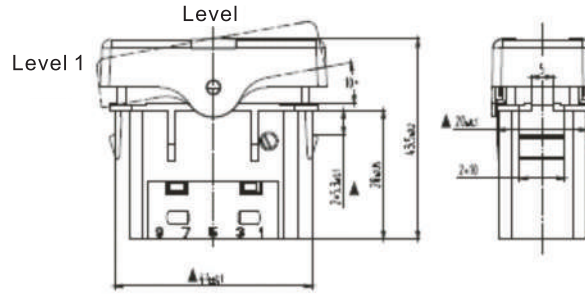

Voltage: 24V
Application: North Mercedes
H06A

Case Qty: 500pcs

SORL	Drawing	Icon	Remark
RLD5-I079-01	3792 029 014 0		1,3,7,10
RLD5-I079-02	3792 029 015 0		3,4,5,6,7,8,
RLD5-I079-03	3792 052 030 0		1,3,5,7,10
RLD5-I079-04	3792 052 031 0		1,3,5,7,10
RLD5-I079-05	3792 052 032 0		1,3,5,7,10
RLD5-I079-06	3792 052 033 0		1,3,5,7,10
RLD5-I079-07	3792 052 034 0		1,3,5,7,10
RLD5-I079-08	3792 052 035 0		1,3,5,7,10
RLD5-I079-09	3792 052 036 0		1,3,5,7,10
RLD5-I079-10	3792 052 037 0		1,3,5,7,10
RLD5-I079-11	3792 052 038 0		1,3,5,7,10
RLD5-I079-12	3792 052 039 0		1,3,5,7,10
RLD5-I079-13	3792 052 040 0		1,3,5,7,10
RLD5-I079-14	3792 052 041 0		1,3,5,7,10
RLD5-I079-15	3792 052 042 0		1,3,5,7,10

SORL	Drawing	Icon	Remark
RLD5-I079-16	3792 052 043 0		1,3,5,7,10
RLD5-I079-17	3792 052 044 0		1,3,5,7,10
RLD5-I079-18	3792 052 045 0		1,3,5,7,10
RLD5-I079-19	3792 052 046 0		1,3,5,7,10
RLD5-I079-20	3792 052 047 0		1,3,5,7,10
RLD5-I079-21	3792 052 048 0		1,3,4,5,6,7,8,10
RLD5-I079-22	3792 052 049 0		1,3,4,5,6,7,8,10
RLD5-I079-23	3792 052 050 0		1,3,4,5,6,7,8,10
RLD5-I079-24	3792 052 051 0		1,3,4,5,6,7,8,10
RLD5-I079-25	3792 052 052 0		1,3,5,7,10
RLD5-I079-26	3792 052 053 0		1,3,5,7,10
RLD5-I079-27	3792 052 054 0		1,3,5,7,10
RLD5-I079-28	3792 052 055 0		1,3,5,7,10
RLD5-I079-29	3792 052 056 0		1,3,5,7,10
RLD5-I079-30	3792 052 057 0		1,3,5,7,11

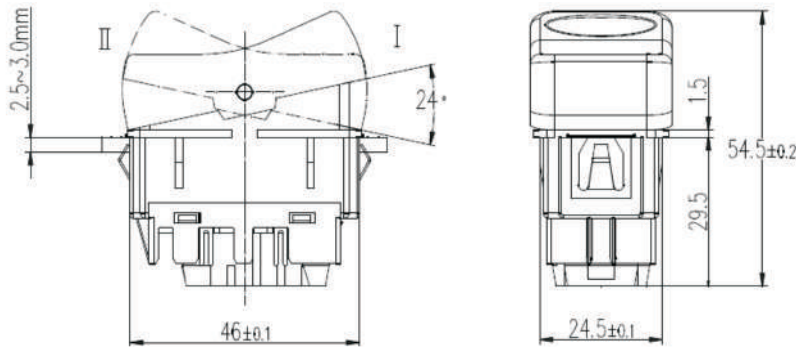





Voltage: 24V
Application: HuaLing
H08





Case Qty: 500pcs





SORL	Drawing	Icon	Remark
RLD5-I080-01	3792 022 002 0		
RLD5-I080-02	3792 022 017 0		
RLD5-I080-03	3792 022 019 0		
RLD5-I080-04	3792 022 003 0		
RLD5-I080-05	3792 022 021 0		
RLD5-I080-06	3792 022 011 0		
RLD5-I080-07	3792 022 008 0		
RLD5-I080-08	3792 022 009 0		
RLD5-I080-09	3792 022 004 0		
RLD5-I080-10	3792 022 018 0		
RLD5-I080-11	3792 022 012 0		
RLD5-I080-12	3792 022 023 0		
RLD5-I080-13	3792 022 005 0		
RLD5-I080-14	3792 022 016 0		
RLD5-I080-15	3792 022 020 0		
RLD5-I080-16	3792 022 024 0		
RLD5-I080-17	3792 022 013 0		

SORL	Drawing	Icon	Remark
RLD5-I080-18	3792 022 022 0		1,3,5,7,10
RLD5-I080-19	3792 022 025 0		1,3,5,7,10
RLD5-I080-20	3792 022 015 0		1,3,5,7,10
RLD5-I080-21	3792 022 007 0		1,3,5,7,10
RLD5-I080-22	3792 022 010 0		1,3,5,7,10
RLD5-I080-23	3792 022 001 0		1,3,4,5,6,7,8,10
RLD5-I080-24	3792 022 014 0		1,3,4,5,6,7,8,10
RLD5-I080-25	3792 022 006 0		1,3,4,5,6,7,8,10
RLD5-I080-26	3792 022 026 0		1,3,4,5,6,7,8,10
RLD5-I080-27	3792 022 027 0		1,3,5,7,10
RLD5-I080-28	3792 022 028 0		1,3,5,7,10
RLD5-I080-29	3792 022 029 0		1,3,5,7,10
RLD5-I080-30	3792 022 030 0		1,3,5,7,10
RLD5-I080-31	3792 022 031 0		1,3,5,7,10
RLD5-I080-32	3792 022 032 0		1,3,5,7,11
RLD5-I080-33	3792 022 033 0		1,3,5,7,12



Pictures And, or OEM Part Numbers are for reference purpose only.



Door Lock	
	<p>RLD5-J001 Drawing: 3787 015 001 0 Left: 3817230201 3817230301</p>
	<p>RLD5-J001A Drawing: 3787 015 002 0 Right: 3817230001 3717230101</p> <p>Application Mercedes</p>
	<p>RLD5-J019 Left Drawing: 3789 017 001 0</p>
	<p>RLD5-J019A Right Drawing: 3787 0170020</p> <p>Cross 8024B(L&R)</p>
	<p>RLD5-J020 Drawing: 3787 013 001 0</p>
	<p>RLD5-J020A Drawing: 3787 013 002 0</p>

Window Winder	
	<p>RLD5-J002 Drawing: 3789 004 001 0 Drive: Left-hand</p> <p>Cross 6417200246 Application DC</p>
	<p>RLD5-J003 Drawing: 3789 004 002 0 Drive: Right-hand Width: 50mm</p> <p>Cross 6417200346 Application Mercedes</p>
	<p>RLD5-J016 Drawing: 3789 003 001 0</p> <p>Cross 3227250202 Application DC</p>
	<p>RLD5-J017 Drawing: 3789 003 002 0</p> <p>Cross 3227250302 Application Mercedes Truck 924 6CYL</p>





Window Regulator	
	RLD5-J018 Drawing: 3789 005 001 0
Cross	3T361989040
Application	Mercedes
	RLD5-J022 Left Drawing: 3790 011 001 0
	RLD5-J022A Right Drawing: 3790 011 002 0
Cross	83010
	RLD5-J023 Left Drawing: 3790 011 001 0
	RLD5-J023A Right Drawing: 3790 011 002 0



	RLD5-J024 Left Drawing: 3789 002 001 0
	RLD5-J024A Right Drawing: 3798 002 002 0

Door Handle	
	RLD5-J004 Left Drawing: 3787 010 001 0
	RLD5-J004A Right Drawing: 3787 010 002 0 Color: Black
Cross	3814660901 3817600259 3817660901 6317601259 6707600159
Application	Mercedes
	RLD5-J005 Left Drawing: 3787 009 001 0

Door Handle	
RLD5-J005A	
Right Drawing: 3787 009 002 0 Color: Black Both Sides With Key	
Cross	3227660701 460516
Application	Mercedes Truck917
RLD5-J006	
Left Drawing: 3787 008 001 0	
	
RLD5-J006A	
Right Drawing: 3787 008 002 0 Color: Black	
Cross	12017.0159NEW
Application	Mercedes Truck917
RLD5-J009	
Left Drawing: 3787 011 001 0	
	
Cross	Left 6417600259
RLD5-J009A	
Right Drawing: 3787 011 002 0 Color: Black	
Cross	Right 6417600359
Application	Mercedes



RLD5-J021	
Left Drawing: 3787 012 001 0	
	
RLD5-J021A	
Right Drawing: 3787 012 002 0 Color: Black	
Application	Scaina

Flash Relay	
RLD5-K001	
	Drawing : 3766 020 001 0 Voltage: 24V
Cross	4DW 004 356-00
Application	Mercedes
RLD5-K002	
	Drawing : 3766 007 001 0 Voltage: 24V
Cross	068500-2900 36AD-40020
Application	Cnew Version
RLD5-K002A	
	Drawing : 3766 007 002 0 Voltage: 24V
Cross	36ADQ-40020
RLD5-K003	
	Drawing : 3766 019 001 0 Voltage: 24V
Cross	4DW 004 834-12 4DZ002034-16
Application	Mercedes
RLD5-K004	
	Drawing : 3766 027 001 0 Voltage: 24V
Cross	4DM001863-08 SGD143
Application	Mercedes

	RLD5-K005
	Drawing : 3766 022 001 0 Voltage: 24V
Cross	1B24937500031
Application	Auman
	RLD5-K011
	Drawing : 3766 024 001 0 Voltage: 24V
Cross	3801-15810
Application	Hongyan
	RLD5-K014
	Drawing : 3766 004 001 0 Voltage: 24V
Cross	3726030-50 SGD2501
Application	FAW CA151
	RLD5-K015
	Drawing : 3766 002 001 0 Voltage: 24V
Cross	79100580160 SGD242
Application	ST Mercedes

Flash Relay	
	RLD5-K025
	Drawing : 3766 010 001 0 Pins: 18 Voltage: 24V
Cross	0035445032 0035443032 0035443732 0035444332 0035446132
Application	Mercedes
	RLD5-K028
	Drawing : 3766 012 001 0 Pins: 3 Voltage: 12V
Cross	EF0312
	RLD5-K029
	Drawing : 3766 012 002 0 Pins: 2 Voltage: 12V
Cross	EF0212
	RLD5-K030
	Drawing : 3766 013 001 0 Pins: 3 Voltage: 12V
Cross	EF0316
	RLD5-K031
	Drawing : 3766 015 001 0 Pins: 2 Voltage: 12V
Cross	EF0212H



	RLD5-K032
	Drawing : 3766 015 002 0 Pins: 3 Voltage: 12V
Cross	EF0312H
	RLD5-K033
	Drawing : 3766 013 002 0 Pins: 3 Voltage: 12V
Cross	EF0320
	RLD5-K034
	Drawing : 3766 014 001 0 Pins: 2 Voltage: 12V
Cross	EF0216
	RLD5-K035
	Drawing : 3766 014 002 0 Pins: 2 Voltage: 12V
Cross	EF0220
	RLD5-K036
	Drawing : 3766 016 002 0 Pins: 3 Voltage: 12V
Cross	EF0312L
	RLD5-K037
	Drawing : 3766 016 001 0 Pins: 2 Voltage: 12V
Cross	EF0212L

Flash Relay	
RLD5-K043	
	Drawing : 3766 034 001 0 Pins: 3 Color: Green
Cross	81980-22070 066500-0791 Color:Green 81980-22060 81980-22040 Color:Black 81980-36010 81980-36040 81980-36060
Application	Toyota
RLD5-K047	
	Drawing : 3766 021 001 0 Voltage: 24V
Cross	1B24937500031
Application	Mercedes
RLD5-K049	
	Drawing : 3766 026 001 0 Voltage: 24V
Cross	SG254B
RLD5-K049A	
	Drawing : 3766 026 002 0 Voltage: 12V
Application	GM

RLD5-K050	
	Drawing : 3766 026 003 0 Voltage: 24V
Cross	SG254C
RLD5-K050A	
	Drawing : 3766 026 004 0 Voltage: 12V
Cross	SG254C
RLD5-K051	
	Drawing : 3766 008 001 0 Voltage: 24V 9Pins
Cross	81253110005 81253110009 81253110012 81253110024 81253110025 81253110027
RLD5-K051A	
	Drawing : 3766 008 002 0 Voltage: 24V
Cross	81253110006 81253110010 81253110013 81253110026 81253110028
Application	MAN TGA(TGS)

Flash Relay	
	<p>RLD5-K062</p> <p>Drawing : 3766 005 001 0 Voltage: 24V</p>
	<p>RLD5-K063</p> <p>Drawing : 3766 010 001 0 Voltage: 24V Pins: 11</p> <p>Cross 003 544 5332 Application Mercedes</p>
	<p>RLD5-K064</p> <p>Drawing : 3766 011 001 0 Voltage: 12V</p> <p>Cross 4DM003360-00 4DM004420-04</p>
	<p>RLD5-K075</p> <p>Drawing : 3766 009 001 0 Rated Voltage: 24V</p> <p>Cross 3735015-C0100</p>
	<p>RLD5-K081</p> <p>Drawing : 3766 055 001 0</p> <p>Cross 36A43D-40021 Application XingMa</p>



RLD5-K082	
	<p>Drawing : 3766 055 002 0</p> <p>Cross 36A43D-40020 Application XingMa</p>

Controller	
	<p>RLD5-K006</p> <p>Drawing : 3735 027 001 0 Voltage: 24V</p> <p>Cross 1B24937500006 Application Auman GenLvon Howo Hongyan Balong</p>
	<p>RLD5-K008</p> <p>Drawing : 3735 029 001 0 Voltage: 24V</p> <p>Cross 3741060-240 Application Mitsubishi FAW FP</p>
	<p>RLD5-K009</p> <p>Drawing : 3735 030 001 0 Voltage: 24V</p> <p>Cross 1B24937500004 Application Auman</p>

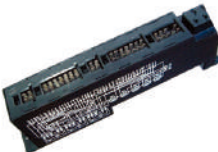
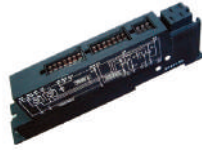
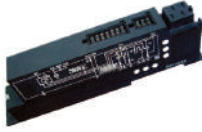

Controller	
 <p>Drawing : 3735 031 001 0 Voltage: 24V</p> <p>Cross 3818080-240 Application FAW</p>	RLD5-K010
 <p>Drawing : 3766 028 001 0 Voltage: 24V</p> <p>Cross 3801-16510 Application ST</p>	RLD5-K012
 <p>Drawing : 3766 029 001 0 Voltage: 24V</p> <p>Cross 1B2493750002 Application Auman</p>	RLD5-K013
 <p>Drawing : 3735 016 001 0 Voltage: 24V</p> <p>Cross JG2501-24V, 3740060-50 Application FAW CA151, Hongyan</p>	RLD5-K016
 <p>Drawing : 3735 006 001 0 Voltage: 24V</p> <p>Cross 001 542 4819 Application Mercedes, MAN, Scania</p>	RLD5-K017







 <p>Drawing : 3735 016 002 0 Voltage: 24V</p> <p>Cross 3740060-50(24V) Application Mitsubishi Ca series</p>	RLD5-K018
 <p>Drawing : 3735 009 001 0 Voltage: 24V Pins: 10</p> <p>Cross 81253110023 Application MAN Scania</p>	RLD5-K052
 <p>Drawing : 3735 019 001 0 Voltage: 24V</p> <p>Cross 3763040 C170 Application FAW</p>	RLD5-K065
 <p>Drawing : 3735 021 001 0 Voltage: 24V</p> <p>Cross 960959877</p>	RLD5-K068

Controller	
	<p align="right">RLD5-K070</p> <p>Drawing : 3735 023 002 0</p> <p>Cross 620 540 0624 000 545 1324</p> <p>Application Mercedes</p>
	<p align="right">RLD5-K071</p> <p>Drawing : 3766 023 001 0 Rated Voltage: 24V</p> <p>Cross 0005431015 0005432815 0005439015 0005431915 0005432415 0005437815</p> <p>Application Mercedes</p>
	<p align="right">RLD5-K072</p> <p>Drawing : 3722 003 001 0 Rated Voltage: 24V Same as RLD5-G013</p> <p>Cross 0005439015</p> <p>Application Mercedes</p>
	<p align="right">RLD5-K073</p> <p>Drawing : 3722 003 002 0 Rated Voltage: 24V Same as RLD5-G015</p> <p>Application 0005438915</p> <p>Application Mercedes</p>

	<p align="right">RLD5-K074</p> <p>Drawing : 3735 011 001 0 Rated Voltage: 24V</p> <p>Cross 3735020-C0100</p>
	<p align="right">RLD5-K076</p> <p>Drawing : 3735 054 001 0 Voltage: 24V</p> <p>Cross 69200580074</p> <p>Application ST</p>
	<p align="right">RLD5-K077</p> <p>Drawing No: 3766 054 001 0 Voltage: 24V</p>
	<p align="right">RLD5-K078</p> <p>Drawing : 3735 059 001 0 Voltage: 24V</p> <p>Cross 37Z63J-35510</p> <p>Application LiFang TianLong</p>

Controller	
	<p align="right">RLD5-K079</p> <p>Drawing : 3735 058 001 0 Voltage: 24V</p>
Cross	3638010-C0100
Application	LiFang
	<p align="right">RLD5-K080</p> <p>Drawing : 3735 062 001 0 Voltage: 24V</p>
Application	ST

Relay	
	<p align="right">RLD5-K007</p> <p>Drawing : 3735 028 001 0 Voltage: 24V Pins: 4</p>
Cross	4RA003510081 4P
Application	Mercedes DAF Volvo
	<p align="right">RLD5-K019</p> <p>Drawing : 3735 032 002 0 Pins: 4 Voltage: 24V</p>
	<p align="right">RLD5-K019A</p> <p>Drawing : 3735 032 001 0 Pins: 4 Voltage: 12V</p>
Cross	JD2912
Application	Realy

	<p align="right">RLD5-K020</p> <p>Drawing : 3735 033 002 0 Pins: 5 Voltage: 24V</p>
	<p align="right">RLD5-K020A</p> <p>Drawing : 3735 033 001 0 Pins: 5 Voltage: 12V</p>
Cross	JD2914
Application	Realy
	<p align="right">RLD5-K021</p> <p>Drawing : 3735 034 002 0 Pins: 4 Voltage: 24V</p>
	<p align="right">RLD5-K021A</p> <p>Drawing : 3735 033 001 0 Pins: 4 Voltage: 12V</p>
Cross	JD2912
	<p align="right">RLD5-K022</p> <p>Drawing : 3735 035 002 0 Pins: 4 Voltage: 24V Current: 30A</p>
	<p align="right">RLD5-K022A</p> <p>Drawing : 3735 035 001 0 Pins: 4 Voltage: 12V Current: 30A</p>
Cross	JD2912

Relay	
	<p>RLD5-K023</p> <p>Drawing : 3735 036 002 0 Voltage: 24V Current: 30A</p>
	<p>RLD5-K023A</p> <p>Drawing : 3735 036 001 0 Voltage: 12V Current: 30A</p>
Cross	JD2912
	<p>RLD5-K024</p> <p>Drawing : 3735 037 001 0 Voltage: 24V Current: 30A</p>
Cross	JD2914
	<p>RLD5-K044</p> <p>Drawing : 3766 035 001 0 Voltage: 24V Pins: 5</p>
Cross	MC-843788
Application	Mitsubishi
	<p>RLD5-K045</p> <p>Drawing : 3766 036 002 0 Voltage: 24V Pins: 4</p>
	<p>RLD5-K045A</p> <p>Drawing : 3766 036 001 0 Voltage: 12V Pins: 4</p>
Application	Mitsubishi

	<p>RLD5-K046</p> <p>Drawing : 3766 037 002 0 Voltage: 24V Pins: 3</p>
	<p>RLD5-K046A</p> <p>Drawing : 3766 037 001 0 Voltage: 12V Pins: 3</p>
Application	Mitsubishi
	<p>RLD5-K048</p> <p>Drawing : 3766 038 002 0 Voltage: 24V Pins: 5</p>
Cross	001 542 1119
	<p>RLD5-K048A</p> <p>Drawing : 3766 038 001 0 Voltage: 12V</p>
Application	Mercedes
	<p>RLD5-K053</p> <p>Drawing : 3735 038 001 0 Voltage: 24V</p>
Cross	0035458105
Application	Mercedes

Starting Relay

RLD5-K041



Drawing : 3818 007 001 0

Cross JD2912
331 101 006
Application Mercedes, Bosch

RLD5-K042



Drawing : 3818 008 001 0

Cross 331 490 001
Application Mercedes

Relay with Display

RLD5-G010



Drawing: 3735 020 001 0
Voltage: 24V

Hazard Flasher Switch

RLD5-L001



Drawing No: 3792 507 002 0
Voltage: 24

Cross 6HF 002 372 051
A0045450224
004 545 0224
81.25503.0130
88.25503.0062 1571337
Application Mercedes
Evobus
MAN
Volvo

RLD5-L002



Drawing No: 3792 501 001 0
Voltage: 24

Application Mercedes

RLD5-L003



Drawing No: 3792 501 002 0
Voltage: 24

Cross 002 545 7124
6HF 001 579 011
Application Ivceo JN162
2446984
MAN 81.25503.0053
Renault 5000360312





RLD5-L004



Drawing No: 3792 509 001 0
Voltage: 24



Cross 000 545 9311
Application Mercedes 355

Electronic Regulator	
RLD5-N001	
	Drawing: 3702 001 001 0 Reg Bo:24V Voltage Set Point: 27.5V Slipring Od: 28mm Regulation: A-Circuit
Cross	0192053005 0192053006 0192053011 0192053013
Application	Bosch DAF
RLD5-N003	
	Drawing: 3702 009 001 0 Reg Bo:12V Voltage Set Point: 14.5V Regulation: A-Circuit
Cross	Bosch 1197311026,27,28,35,38,40 1197311041
Application	BMW 12711726022 Audi, VW 03490803
RLD5-N004	
	Drawing: 3702 010 001 0 Voltage Set Point: 14.5V Reg Bo:12V Slipring Od: 14mm Regulation: A-Circuit
Cross	Bosch 1197311213
Application	Mercedes
RLD5-N005	
	Drawing: 3702 011 001 0 Reg Bo:12V Voltage Set Point: 14.5V Slipring Od: 14mm Regulation: A-Circuit
Cross	Bosch 119731232,234,239,513,514
Application	Volvo 9130110, 9130518 Opel 90540408, 1204275 Saab 4737151

RLD5-N006	
	Drawing: 3702 011 002 0 Reg Bo:12V Voltage Set Point: 14.5V Slipring Od: 14mm Regulation: A-Circuit
Cross	Bosch 197311021
RLD5-N007	
	Drawing: 3702 012 001 0 Reg Bo:12V Voltage Set Point: 14.1V Slipring Od: 32mm Regulation: A-Circuit
Cross	Bosch 0192052001, 02, 90 2197311090, 1179311090
Application	Audi/VW 028903803A 049903803B 049903803BE 049903803EF
RLD5-N014	
	Drawing: 3702 014 001 0 Reg Bo:12V Voltage Set Point: 14.4V Regulation: A-Circuit
RLD5-N015	
	Drawing: 3702 004 002 0 Reg Bo:12V Voltage Set Point: 14.4V Regulation: A-Circuit
Cross	162.0084
Application	Renault



Electronic Regulator		
RLD5-N016		
	Drawing: 3702 002 002 0 Reg Bo:24V Voltage Set Point: 28.3V Regulation: A-Circuit	
Cross	Bosch	0192033003 0192033005
Application	Cummins Komatsu	300586 6102617
RLD5-N017		
	Drawing: 3702 002 001 0 Reg Bo:24V Voltage Set Point: 28.3V Regulation: A-Circuit	
Cross	Bosch	0192033001, 02, 04
	Ford	11635831
	Iskra	11125026, 11125105 AER2907 AER3002
Application	Volvo, Cummins, Bosch, Ford, Iskra	
RLD5-N018		
	Drawing: 3702 003 001 0 Reg Bo: 24V Voltage Set Point: 28.5V Regulation: A-Circuit	
RLD5-N033		
	Drawing: 3702 004 001 0 Reg Bo:24V Voltage Set Point: 28.4V Regulation: A-Circuit	

RLD5-N038	
	Drawing: 3702 006 001 0 Reg Bo:24V Voltage Set Point: 28.5V Regulation: A-Circuit





Disc Type Horn	
RLD5-P001	
	Drawing: 3721 002 0010 Bass Frequency: 310±20Hz Treble Frequency: 370±20Hz Diameter Φ127mm Voltage: 24V
Cross	DL50GD
RLD5-P001A	
	Drawing: 3721 002 008 0 Voltage: 12V
Application	Audi
RLD5-P002	
	Drawing: 3721 001 017 0 Bass Frequency: 320~400Hz Treble Frequency: 420~500Hz Diameter: Φ87mm Voltage: 12V
Cross	DL125GD
RLD5-P002A	
	Drawing: 3721 001 015 0 Voltage: 24V
Application	In common Vehicle
RLD5-P005	
	Drawing: 3721 004 001 0 Frequency: 420~500Hz Diameter: Φ87mm Voltage: 12V Color: Black
Cross	DL124G

RLD5-P005A	
	Drawing: 3721 004 002 0 Voltage: 24V
Application	FAW Auman
RLD5-P008	
	Drawing: 3721 002 002 0 Frequency: 370±25Hz
Cross	DL50G 002 542 6820
Application	Mercedes
RLD5-P008A	
	Drawing: 3721 002 003 0 Frequency: 310±20Hz Diameter: Φ127mm Voltage: 24V
Cross	002 542 6720 DL50D
RLD5-P009	
	Drawing: 3721 001 002 0 Diameter: Φ90mm Voltage: 12V
Cross	DL125G
Application	HCV, LCV Agricultural Vehicle Mini Vehicle, Car

Disc Type Horn	
	RLD5-P012 Drawing: 3721 005 001 0 Diameter: Φ90mm Voltage: 12V Color: Red
Cross	DL124G
	RLD5-P012A Drawing: 3721 005 003 0 Voltage: 24V
Application	FAW Auman
	RLD5-P014 Drawing: 3721 006 001 0 Voltage: 24V
Cross	DL50B
Application	HCV, LCV, Agricultural Vehicle Mini Vehicle, Car
	RLD5-P060 Drawing: 3754 033 001 0
	RLD5-P061 Drawing: 3721 305 002 0
	RLD5-P062 Drawing: 3721 305 003 0

Fanfare Horn	
	RLD5-P004 Drawing: 3721 301 012 0 Voltage(V): 12/24V Color: Black and Red
Cross	DL32GD
	RLD5-P004A Drawing: 3721 301 001 0 Color: Black
Cross	DL32L-12
	RLD5-P004B Drawing: 3721 301 002 0 Color: Black
Cross	DL32H-12
	RLD5-P004C Drawing: 3721 301 007 0 Color: Black
Cross	DL32L-24
	RLD5-P004D Drawing: 3721 301 004 0 Color: Black
Cross	DL32H-24
Application	In common Vehicle
	RLD5-P013 Drawing: 3798 301 001 0 Voltage: 24V
Cross	65A00078, 1341796 1514259, 1771638 1784671, 1874273 1874274, 514259
Application	Scania, Volvo



Fanfare Horn	
	<p>RLD5-P015</p> <p>Drawing: 3721 007 001 0 Voltage: 24V Bass Frequency: 410Hz Treble Frequency: 510Hz</p> <p>Cross 805</p>
	<p>RLD5-P020</p> <p>Drawing: 3721 302 001 0 Voltage: 24V Bass Frequency: 290~340Hz Treble Frequency: 350~420Hz Sound level: 105~125dB</p> <p>Cross DL34G/D Application In common Vehicle</p>
	<p>RLD5-P021</p> <p>Drawing: 3721 008 001 0 Treble Frequency: 350~420Hz Voltage: 24V</p> <p>Cross DL34G Application In common Vehicle</p>
	<p>RLD5-P059</p> <p>Drawing: 3721 009 001 0 Voltage: 24V</p> <p>Cross DL137G/D</p>
	<p>RLD5-P059A</p> <p>Drawing: 3721 009 002 0 Voltage: 12V</p>





Electrical Controlled Air Horn	
	<p>RLD5-P028</p> <p>Drawing: 3798 002 007 0 Sound level: 105~125dB Voltage: 24V Length: 235, 300mm</p>
	<p>RLD5-P029</p> <p>Drawing: 3798 002 006 0 Sound level: 105~125dB Voltage: 12V Length: 235, 300mm FN/2PC</p>
	<p>RLD5-P030</p> <p>Drawing: 3798 002 005 0 Sound level: 105~125dB Voltage: 24V Length: 235, 300mm FN/2PC</p>
	<p>RLD5-P030A</p> <p>Drawing: 3798 002 009 0 Voltage: 12V</p>
	<p>RLD5-P034</p> <p>Drawing: 3798 007 001 0 Length: 235, 300mm</p>
	<p>RLD5-P036</p> <p>Drawing: 3798 008 001 0 Sound level: 105~125dB Voltage: 24V</p>
	<p>RLD5-P036A</p> <p>Drawing: 3798 008 002 0 Voltage: 12V</p>

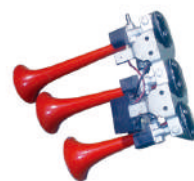

Electrical Controlled Air Horn	
	<p>RLD5-P037</p> <p>Drawing: 3798 002 003 0 Sound level: 105~125dB Voltage: 24V Length: 235, 300mm</p>
Application	In common Vehicle
	<p>RLD5-P037A</p> <p>Drawing: 3798 0020190 Voltage: 12V</p>
	<p>RLD5-P038</p> <p>Drawing: 3798 002 013 0 Sound level: 105~125dB Voltage: 24V Length: 235, 300mm</p>
Cross	WG9100270065
Application	CNHTC
	<p>RLD5-P039</p> <p>Drawing: 3798 002 002 0 Sound level: ≥125dB Voltage: 24V Length: 235, 300mm</p>
	<p>RLD5-P040</p> <p>Drawing: 3798 002 001 0 Sound level: 105~125dB Voltage: 24V Length: 235, 300mm</p>



	<p>RLD5-P041</p> <p>Drawing: 3798 009 001 0 Length: 165, 230, 300mm</p>
	<p>RLD5-P042</p> <p>Drawing: 3798 009 002 0 Length: 165, 230, 300mm</p>
	<p>RLD5-P043</p> <p>Drawing: 3798 010 001 0 Length: 190, 250, 330mm</p>
	<p>RLD5-P044</p> <p>Drawing: 3798 002 008 0 Sound level: 105~125dB Voltage: 24V Length: 235, 300mm</p>
Cross	26310DB810
	<p>RLD5-P045</p> <p>Drawing: 3798 001 004 0 Sound level: 105~125dB Voltage: 24V Length: 640mm</p>
	<p>RLD5-P045A</p> <p>Drawing: 3798 0010050 Voltage: 12V</p>
	<p>RLD5-P046</p> <p>Drawing: 3798 011 001 0 Sound level: 105~125dB Voltage: 24V</p>





Electrical Controlled Air Horn	
	<p>RLD5-P047</p> <p>Drawing: 3798 012 001 0 Sound level: 105~125dB Voltage: 24V Length: 640mm</p>
	<p>RLD5-P048</p> <p>Drawing: 3798 013 001 0 Sound level: 105~125dB Voltage: 24V Length: 640mm</p>
	<p>RLD5-P049</p> <p>Drawing: 3798 014 001 0 Sound level: 105~125dB Voltage: 24V Length: 640mm</p>
	<p>RLD5-P050</p> <p>Drawing: 3798 014 002 0 Sound level: 105~125dB Voltage: 24V Length: 740mm</p>
	<p>RLD5-P051</p> <p>Drawing: 3798 001 006 0 Sound level: 105~125dB Voltage: 24V Length: 740mm</p>
	<p>RLD5-P052</p> <p>Drawing: 3798 013 002 0 Sound level: 105~125dB Voltage: 24V Length: 700mm</p>
	<p>RLD5-P053</p> <p>Drawing: 3798 015 001 0 Sound level: 105~125dB Voltage: 24V</p>

	<p>RLD5-P055</p> <p>Drawing: 3798 016 001 0</p>
	<p>RLD5-P056</p> <p>Drawing: 3798 017 001 0</p>
	<p>RLD5-P057</p> <p>Drawing: 3798 006 001 0 Sound level: 105~125dB Voltage: 24V</p>
	<p>RLD5-P058</p> <p>Drawing: 3798 001 002 0 Sound level: 105~125dB Voltage: 24V</p>
Application	Foom 145 307

Solenoid Valve	
RLD5-R001	
	Drawing: 3754 001 001 0 Voltage: 24V Intake Pressure: 1MPa
Application	FAW
RLD5-R002	
	Drawing: 3754 001 002 0 Voltage: 24V Intake Pressure: 1MPa
Application	FAW
RLD5-R003	
	Drawing: 3754 001 007 0 Voltage: 24V Intake Pressure: 1MPa
Cross	3754010-Q320
Application	FAW
RLD5-R004	
	Drawing: 3754 001 015 0 Voltage: 24V Intake Pressure: 1MPa
Cross	3754010-Q304
Application	FAW

RLD5-R005	
	Drawing: 3754 001 006 0 Voltage: 24V Intake Pressure: 1MPa
Cross	3754030-Q422K
Application	FAW
RLD5-R006	
	Drawing: 3754 001 005 0 Voltage: 24V Intake Pressure: 1MPa
Cross	3754010-Q422
Application	FAW
RLD5-R007	
	Drawing: 3754 028 001 0 Voltage: 24V Intake Pressure: 1MPa
Application	Q116
RLD5-R008	
	Drawing: 3754 001 014 0 Voltage: 24V Intake Pressure: 1MPa
Cross	3754010K1H(DF252)
Application	FAW CA151

Two-position Three Way Solenoid Valve	
	RLD5-R009
	Drawing: 3754 002 006 0 Voltage: 24V Intake Pressure: 1MPa
Cross	37N-54010 37N-54010(DF251)
Application	DongFeng EQ153
	RLD5-R010
	Drawing: 3754 002 011 0 Voltage: 24V Intake Pressure: 1MPa
Cross	3754010A8E
Application	DongFeng
	RLD5-R011
	Drawing: 3754 002 010 0 Voltage: 24V Intake Pressure: 1MPa
Cross	3754010A8E-LT
Application	DongFeng
	RLD5-R012
	Drawing: 3754 002 002 0 Voltage: 24V Intake Pressure: 1MPa
Cross	DF254
Application	DongFeng

	RLD5-R013
	Drawing: 3754 002 005 0 Voltage: 24V Intake Pressure: 1MPa
Cross	35AD-49020 DF357
Application	Mistubishi
	RLD5-R014
	Drawing: 3754 016 001 0 Voltage: 24V Intake Pressure: 1MPa
Cross	6606Z06-010
Application	DongFeng EQ153
	RLD5-R015
	Drawing: 3754 011 001 0 Voltage: 24V Intake Pressure: 1MPa
Application	DF261
	RLD5-R017
	Drawing: 3754 010 001 0 Voltage: 24V Intake Pressure: 1MPa
Cross	RZPF313A
Application	STR Delong F2000, F3000

Two-position Three Way Solenoid Valve

RLD5-R018	
	Drawing: 3754 023 001 0 Voltage: 24V Intake Pressure: 1MPa
Cross	AZ79100710008
Application	FAW

RLD5-R022	
	Drawing: 3754 013 001 0 Voltage: 24V Electric Current: 0.8A Intake Pressure: 1MPa
Cross	VF-102

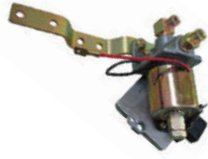

RLD5-R023	
	Drawing: 3754 026 001 0 Voltage: 24V Intake Pressure: 1MPa
Cross	81 61967 0016 81 61967 6022 81 61967 0011 A0028302784 A0018302184 5001844056
Application	MAN F2000 Mercedes



RLD5-R025	
	Drawing: 3754 008 001 0 Voltage: 12V Intake Pressure: 1MPa
Cross	11271

RLD5-R026	
	Drawing: 3754 008 002 0 Voltage: 12V Intake Pressure: 1MPa
Cross	11253

RLD5-R027	
	Drawing: 3754 014 001 0 Voltage: 12V Intake Pressure: 1MPa

RLD5-R029	
	Drawing: 3754 035 001 0 Voltage: 24V Intake Pressure: 1MPa
Cross	H-7B000S

Two-position Three Way Solenoid Valve	
	RLD5-R030A Drawing: 3754 020 002 0 Voltage: 12V
	RLD5-R030B Drawing: 3754 020 003 0 Voltage: 12V
	RLD5-R030C Drawing: 3754 020 004 0 Voltage: 24V
	RLD5-R030D Drawing: 3754 020 005 0 Voltage: 24V
	RLD5-R031 Drawing: 3754 001 025 0 Voltage: 24V Intake Pressure: 1MPa
Cross	3611105-79A
	RLD5-R032 Drawing: 3754 003 021 0 Voltage: 24V Intake Pressure: 1MPa

	RLD5-R033 Drawing: 3754 003 014 0 Voltage: 24V Intake Pressure: 1MPa
	RLD5-R037 Drawing: 3754 009 001 0 Voltage: 12V Intake Pressure: 3MPa
	RLD5-R038 Drawing: 3754 012 006 0 Voltage: 24V Intake Pressure: 1MPa
	RLD5-R039 Drawing: 3754 003 022 0 Voltage: 24V Intake Pressure: 1MPa Connector: M10x1.-6g
Cross	3549010-E15

Two-position Three Way Solenoid Valve	
	<p align="right">RLD5-R042</p> <p>Drawing: 3754 038 001 0 The Same as RLD5-Z070</p>
Cross	RL3516LA AE4
	<p align="right">RLD5-R043</p> <p>Drawing: 3754 012 004 0 M27*1-6g Intake Pressure: 1MPa</p>
	<p align="right">RLD5-R044</p> <p>Drawing: 3754 012 009 0 Intake Pressure: 1MPa</p>
	<p align="right">RLD5-R048</p> <p>Drawing: 3754 012 049 0 Voltage: 24V Air circuit type: Normally closed Inlet port Dia.Φ4mm Exhaust port dia. Φ4mm</p>
Cross	472 070 639 0
Application	Mercedes

	<p align="right">RLD5-R049</p> <p>Drawing: 3754 012 050 0 Voltage: 24V Air circuit type: Normally closed Inlet port Dia.Φ2.2mm Exhaust port dia. Φ3mm</p>								
Cross	472 072 639 0								
Application	<table border="0"> <tr> <td>Daimler</td> <td>0059971136</td> </tr> <tr> <td>DAF</td> <td>1518100</td> </tr> <tr> <td>Daimler</td> <td>A0059971136</td> </tr> <tr> <td>Evobus</td> <td>A0059971136</td> </tr> </table>	Daimler	0059971136	DAF	1518100	Daimler	A0059971136	Evobus	A0059971136
Daimler	0059971136								
DAF	1518100								
Daimler	A0059971136								
Evobus	A0059971136								
	<p align="right">RLD5-R050</p> <p>Drawing: 3754 012 052 0 Voltage: 24V Air circuit type: Normally closed Inlet port Dia.Φ4mm Exhaust port dia. Φ4mm</p>								
Cross	<p>472 170 606 0 99707005851 YC444K072AA 41025616 5010347977 11062023 1470633</p>								
Application	<p>Ford, Iveco Neoplan, Renault, Scania</p>								
	<p align="right">RLD5-R051</p> <p>Drawing: 3754 012 045 0 Voltage: 24V Air circuit type: Normally closed Inlet port Dia.Φ4mm, Exhaust port dia. Φ4mm</p>								
Cross	472 170 616 0								
Application	<table border="0"> <tr> <td>DAF</td> <td>1306727</td> </tr> <tr> <td>Scania</td> <td>1934958</td> </tr> <tr> <td>Evobus</td> <td>A0004206071</td> </tr> </table>	DAF	1306727	Scania	1934958	Evobus	A0004206071		
DAF	1306727								
Scania	1934958								
Evobus	A0004206071								

Two-position Three Way Solenoid Valve

RLD5-R052	
	Drawing: 3754 012 054 0 Voltage: 24V Air circuit type: Normally opened type
Cross	472 170 796 0
Application	Turck, Tractor, Bus

RLD5-R053	
	Drawing: 3754 012 037 0 Voltage: 24V Air circuit type: Normally opened Inlet port Dia.Φ2.2mm Exhaust port dia. Φ2.2mm
Cross	472 171 000 0 1639096 42546462 5006305805 9472128908 E4420001031
Application	DAF Iveco

RLD5-R054	
	Drawing: 3754 012 051 0 Voltage: 24V Air circuit type: Normally opened Inlet port Dia.Φ2.2mm Exhaust port dia. Φ2.2mm
Cross	472 171 700 0
Application	Scania 1934960 Iveco 41016827 Man 99114710043 Daimler A0049978936 Evobus A0049978936 Fruehauf MO58830

RLD5-R055	
	Drawing: 3754 012 048 0 Voltage: 24V Air circuit type: Normally opened Inlet port Dia.Φ2.2mm Exhaust port dia. Φ2.2mm
Cross	472 171 706 0
Application	DAF 1315508 Scania 1788960 Iveco 504088165



RLD5-R056	
	Drawing: 3754 012 044 0 Voltage: 24V Air circuit type: Normally closed Inlet port Dia.Φ2.2mm Exhaust port dia. Φ3mm
Application	WABCO 472 172 606 0 DAF 1315507





RLD5-R057	
	Drawing: 3754 012 046 0 Voltage: 24V Air circuit type: Normally closed Inlet port Dia.Φ2.2mm Exhaust port dia. Φ3mm
Cross Ref.	472 171 686 0

RLD5-R058	
	Drawing: 3754 012 038 0 Voltage: 24V Air circuit type: Normally opened Inlet port Dia.Φ4mm Exhaust port dia. Φ4mm
Cross	472 173 226 0
Application	Scania 1934971 Iveco 41026588 Krone 515016391 Otokar AIF1913

Two-position Three Way Solenoid Valve	
RLD5-R059	
Drawing: 3754 012 047 0 Voltage: 24V Air circuit type: Normally closed Inlet port Dia.Φ2.2mm Exhaust port dia. Φ2.2mm	
Cross	472 172 786 0
Application	DAF 1315510 Scania 1934970
RLD5-R061	
 Drawing: 3754 055 001 0 Voltage: 12V / 24V Air circuit type: Normally closed Inlet port Dia.Φ2.2mm, Exhaust port dia. Φ2.2mm	
Cross	472 127 140 0 736924, 736925, 0745582, 532941 1232316, 81521606020, 51259020009 M0009974036, 24762043, 002472043, 1591034
Application	DAF MAN Mercedes Renault Volvo
RLD5-R062	
 Drawing: 3754 012 020 0 Voltage: 24V	
Cross	518 431 01 10
Application	Mercedes

RLD5-R063	
Drawing: 3754 012 021 0 Voltage: 24V	
Cross	518 431 02 10
Application	Mercedes
RLD5-R064	
Drawing: 3754 012 022 0 Voltage: 24V	
Cross	518 431 0310
Application	Mercedes
RLD5-R065	
Drawing: 3754 012 023 0 Voltage: 24V	
Cross	518 431 04 10
Application	Mercedes
RLD5-R066	
Drawing: 3754 012 024 0 Voltage: 24V Connector: M12x1.5-6h	
Cross	518 431 05 10
Application	Mercedes

Two-position Three Way Solenoid Valve	
	RLD5-R067
	Drawing: 3754 003 015 0 Voltage: 24V
Cross	2410100H3J10
	RLD5-R068
	Drawing: 3754 012 013 0 Voltage: 24V Connector: M12x1.25-6h
Cross	35AD-14010-4
	RLD5-R069
	Drawing: 3754 012 014 0 Voltage: 24V Connector: M12x1.25-6h
Cross	35AD-14010-5
	RLD5-R070
	Drawing: 3754 012 030 0 Voltage: 24V Connector: M12x1.25-6h
Cross	52310-Y3B00

	RLD5-R071
	Drawing: 3754 001 034 0 Voltage: 24V Connector: M12x1.25-6h
Cross	52310-Y5C0G
	RLD5-R072
	Drawing: 3754 012 008 0 Voltage: 24V Connector: M12x1.25-6h
	RLD5-R073
	Drawing: 3754 003 055 0 Voltage: 24V Connector: M10x1.0-6g
Cross	3549010-E7 3549010-E46
	RLD5-R074
	Drawing: 3754 003 052 0 Voltage: 24V Connector: M10x1.0-6g
Cross Ref.	3549010-E8
	RLD5-R075
	Drawing: 3754 003 012 0 Voltage: 24V Connector: M10x1.0-6g
Cross Ref.	3754010-369 DF257A
Application	FAW JieFang

Two-position Three Way Solenoid Valve

RLD5-R076	
	Drawing: 3754 003 046 0 Voltage: 24V Connector: M10x1.0-6g
	Cross 3754030-D598

RLD5-R077	
	Drawing: 3754 003 050 0 Voltage: 24V Connector: M10x1.0-6g
	Cross 3754010-1K7 Application FAW

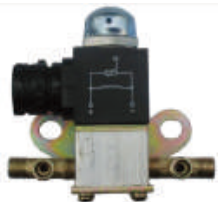
RLD5-R078	
	Drawing: 3754 003 017 0 Voltage: 24V Connector: M10x1.0-6g
	Cross 3751030-0219 Application FAW

RLD5-R079	
	Drawing: 3754 012 033 0 Voltage: 24V Connector: M10x1.0-6g
	Cross 3754010-D598 Application FAW



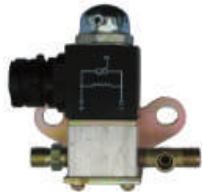

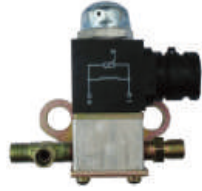
RLD5-R080	
	Drawing: 3754 003 001 0 Voltage: 24V Connector: M10x1.0-6g
	Cross 3754010-240 Application FAW

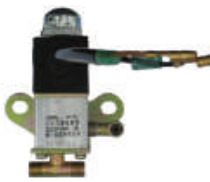

RLD5-R081	
	Drawing: 3754 003 002 0 Voltage: 24V Connector: M10x1.0-6g
	Cross 3754020-260 Application FAW

RLD5-R082	
	Drawing: 3754 003 044 0 Voltage: 24V Connector: M10x1.0-6h
	Cross 3754030-D849 Application FAW



RLD5-R083	
	Drawing: 3754 003 031 0 Voltage: 24V Connector: M10x1.0-6h
	Cross 3549 038 001 8 Application FAW

Two-position Three Way Solenoid Valve

	<p>RLD5-R084</p>
<p>Cross Application</p>	<p>Drawing: 3754 003 054 0 Voltage: 24V Connector: M10x1.0-6h</p> <p>305035140002 FAW</p>
	<p>RLD5-R085</p>
<p>Cross Application</p>	<p>Drawing: 3754 003 035 0 Voltage: 24V</p> <p>35490100118 FAW</p>
	<p>RLD5-R086</p>
<p>Cross Application</p>	<p>Drawing: 3754 003 038 0 Voltage: 24V Connector: M10x1.0-6h</p> <p>35490100138 FAW</p>
	<p>RLD5-R087</p>
<p>Cross Application</p>	<p>Drawing: 3754 001 013 0 Voltage: 24V</p> <p>3557-10-00005 FAW</p>



	<p>RLD5-R088</p>
<p>Cross Application</p>	<p>Drawing: 3754 001 017 0 Voltage: 24V Connector: M14x1.0-6h</p> <p>511 434 00 01 FAW</p>
	<p>RLD5-R089</p>
<p>Cross Application</p>	<p>Drawing: 3754 001 028 0 Voltage: 24V Connector: M10x1.0-6h</p> <p>309035140001 FAW</p>
	<p>RLD5-R090</p>
<p>Cross Application</p>	<p>Drawing: 3754 001 030 0 Voltage: 24V Connector: M10x1.0-6h</p> <p>3557-10-0008 FAW</p>
	<p>RLD5-R091</p>
<p>Cross Application</p>	<p>Drawing: 3754 002 012 0 Voltage: 24V</p> <p>GFD1090P4K FAW</p>

Two-position Three Way Solenoid Valve



RLD5-R092	
	Drawing: 3754 012 001 0 Voltage: 24V Connector: M12x1.5-6h
Application	FAW
RLD5-R093	
	Drawing: 3754 047 006 0 Voltage: 24V Connector: M10x1.0-6h
RLD5-R096	
	Drawing: 3754 014 003 0 Voltage: 24V
Cross	3549 013 007 8
RLD5-R097	
	Drawing: 3754 014 005 0 Voltage: 24V
Cross	3549 013 009 8

Through Way Solenoid Valve





RLD5-R020	
	Drawing: 3754 021 001 0 Voltage: 24V Intake Pressure: 1MPa
Cross	3721115-116A DF152A
Application	Howo



RLD5-R020A	
	Drawing: 3754 021 003 0 Voltage: 24V Intake Pressure: 1MPa
Application	Howo
RLD5-R034	
	Drawing: 3754 027 001 0 Voltage: 24V Intake Pressure: 1MPa

Others

RLD5-R021	
	Drawing: 3754 032 001 0 Voltage: 12V Intake Pressure: 1MPa
RLD5-R098	
	Drawing: 3754 006 001 0 Voltage: 12V
Cross	GM9324822900
RLD5-R099	
	Drawing: 3754 049 002 0 Voltage: 24V Intake Pressure: 1MPa
Cross	3757 042 100 8

Fuel Tank Cap	
RLD5-Z001	
	Drawing: 3711 003 001 0 Inner Diameter: 37.51mm Outer Diameter: 57.7mm Shifting Points(bar): 1.2bar
Cross	000 501 5315
Application	Mercedes
RLD5-Z002	
	Drawing: 3711 004 001 0 Inner Diameter: 37.51mm Outer Diameter: 57.7mm Shifting Points(bar): 1.2bar
Application	Mercedes
RLD5-Z003	
	Drawing: 3711 005 001 0 Inner Diameter: 37.51mm Outer Diameter: 57.7mm Shifting Points(bar): 1.2bar
Cross	123 501 01 05 124 500 01 06 124 501 05 15 129 500 00 06 202 500 04 06
Application	Mercedes
RLD5-Z004	
	Drawing: 3711 006 001 0
Cross	000 501 6415 000 040 1908
Application	Iveco 9316 3623 John Deere AL76 661 Man 81.06111.0018 Mercedes A000 501 64 15

RLD5-Z006	
	Drawing: 3711 007 001 0 Thickness: 25mm Inner Diameter: 36.75mm Outer Diameter: 54mm Shifting Points(bar): 0.7bar
Cross	123 501 4615 000 501 7215
Application	Mercedes Evobus
RLD5-Z009	
	Drawing: 3711 010 001 0 Weight: 0.036Kg
Cross	05080172AA 111 018 0302 000 018 0702 102 018 0080 102 018 0380 344 018 7002 1020180402 1020180302 1020180802
Application	Mercedes
RLD5-Z021	
	Drawing: 3711 008 001 0
Application	Mercedes
RLD5-Z048	
	Drawing: 3711 009 001 0
Application	Steyr

Fuel Tank Cap	
	RLD5-Z081 Drawing: 3711 002 001 0
	RLD5-Z085 Drawing: 3711 012 001 0
	RLD5-Z115 Drawing No: 3711 002 002 0
Cross	1101710-Q407





Diesel Oil Dobber	
	RLD5-Z012 Drawing: 4101 700 001 0
Application	Scania
	RLD5-Z013 Drawing: 4101 701 001 0 180L-220L
	RLD5-Z014 Drawing: 4101 702 001 0 Length: 580mm, 500mm
Application	Mercedes
	RLD5-Z014A Drawing: 4101 702 002 0 Length: 550mm, 470mm
Application	Mercedes
	RLD5-Z014B Drawing: 4101 702 003 0 Length: 460mm, 39.40mm
Application	Mercedes
	RLD5-Z014C Drawing: 4101 702 004 0 Length: 420mm, 360mm
Application	Mercedes

Diesel Oil Dobber	
	RLD5-Z014D Drawing: 4101 702 005 0 Length: 700mm, 500mm
	RLD5-Z015 Drawing: 4101 703 001 0 No.1
	RLD5-Z016 Drawing: 4101 704 001 0 No.2
	RLD5-Z017 Drawing: 4101 705 001 0 No.3
	RLD5-Z018 Drawing: 4101 706 001 0
Cross	000 542 8117 VOD 221825009039C 221825009160C Truck 0142064
Application	Mercedes

Switch	
	RLD5-Z033 Drawing: 4101 211 001 0
Cross	F37A-3N823-AA 3136A
	RLD5-Z033A Drawing: 4101 086 001 0
	RLD5-Z033B Drawing: 4101 086 002 0
	RLD5-Z038 Drawing: 3871 005 001 0 Rated Current: 50A
Application	Mercedes 000 545 6017 Steyr 397580003 Citroen 5 446 209 Deutz-fahr 01163920 Deutz-fahr 276590370 Fiat 5446290 Iveco 5446209
	RLD5-Z045 Drawing: 4101 024 001 0 Voltage: 24V
Cross	286 649
Application	Scania , Series 3

Switch	
RLD5-Z047	
	Drawing: 3709 001 001 0
Cross	000 545 4704 0005453704 80933003001 0005456704
Application	Mercedes
RLD5-Z053	
	Drawing: 3758 006 001 0 Pins: 2
Cross	001 545 1815 002 545 3990
Application	Mercedes
RLD5-Z054	
	Drawing: 4101 101 001 0 Fitted Diameter: 22.5mm Capacity at 12V: 16A Capacity at 24V: 10A
Application	Mercedes 001 545 4914 001 545 0214 Iveco 41822394 GMBH 7311080000
RLD5-Z055	
	Drawing: 4101 102 001 0 Pressure : 5.5bar
Cross	AZ9100589040
Application	Howo



RLD5-Z064	
	Drawing: 4101 053 001 0
Application	Scania Universal
RLD5-Z066	
	Drawing: 4101 615 001 0
Cross	234387
Application	Scania
RLD5-Z073	
	Drawing: 3792 048 001 0 Fitted Diameter 1/2(mm): 27x1
Application	Mercedes 000545 1630 000545 2319 000545 9915 DAF 0678792 167771 EATON 03056 Volvo 4786024
RLD5-Z083	
	Drawing: 4101 616 001 0

Switch	
	RLD5-Z084 Drawing: 4101 054 001 0
Cross	80 545 491 000 545 6314
Application	Mercedes
	RLD5-Z105 Drawing: 4101 617 001 0
	RLD5-Z106 Drawing: 4101 618 001 0
	RLD5-Z107 Drawing: 3709 002 001 0
Cross	000 545 6704
	RLD5-Z117A Drawing: 3709 001 036 8
Cross	2025450081



Cigarette Lighter	
	RLD5-Z043 Drawing: 3725 003 001 0 Voltage: 24V
Cross	37AD-25010
Application	Mitsubishi
	RLD5-Z044 Drawing: 3725 001 001 0 Voltage: 24V
Cross	199000580141
Application	DongFeng TianLong ShanQi AoLong
	RLD5-Z065 Drawing: 3725 007 001 0 Voltage: 24V
Application	DongFeng EQ153 CA Series
	RLD5-Z089 Drawing: 3725 002 001 0
Cross	81289010018 81289010017 81289020004
Application	MAN

Regulator With Seal	
RLD5-Z076	
	Drawing: 4101 622 001 0 Opening Temperature: 65°
Cross	61673540 022039175 0012033975
Application	Mercedes Iveco
RLD5-Z077	
	Drawing: 4101 622 002 0 Opening Temperature: 71°
Cross	0012033975 0022033275 0022035475
Application	Mercedes
RLD5-Z078	
	Drawing: 4101 622 003 0 Opening Temperature: 71°
Application	Renault

Shift Knob	
RLD5-Z068	
	Drawing: 1705 504 001 0
Cross	620 260 0040
Application	Mercedes

Shift Knob	
RLD5-Z082	
	Drawing: 1705 501 001 0
Cross	81970106011 585LL
RLD5-Z090	
	Drawing: 1705 506 001 0
Application	Scania
RLD5-Z090A	
	Drawing: 1705 506 002 0
Cross	384970
Application	Scania
RLD5-Z090B	
	Drawing: 1705 506 003 0
Cross	384970 1369975
Application	Scania

RLD5-Z100	
	Drawing: 1705 502 002 0
Cross	3088-A6913
RLD5-Z101	
	Drawing: 1705 502 001 0
Cross	3088-A6915
RLD5-Z102	
	Drawing: 1705 501 002 0
Application	DAF
RLD5-Z103	
	Drawing: 1705 503 002 0
Application	A4491
RLD5-Z104	
	Drawing: 1705 503 001 0
Cross	A4487



Shift Knob	
RLD5-Z110	
	Drawing: 1705 502 013 0
Cross	A6909
Application	Truck
RLD5-Z111	
	Drawing: 1705 502 014 0
Cross	A6910
Application	Truck
RLD5-Z112	
	Drawing: 1705 508 001 0
Cross	20488052 1521394 3192255
Application	Volvo Scania
RLD5-Z114	
	Drawing: 1705 507 001 0

Shift Knob	
RLD5-Z113	
	Drawing: 1705 509 001 0
Cross	1655853
Application	Volvo
RLD5-Z118	
	Drawing: 1705 510 001 0
Cross	4630550500
Application	Volvo 1655854
RLD5-Z120	
	Drawing: 1705 512 001 0
Cross	4630550520 1665981
Application	Volvo Scania
RLD5-Z121	
	Drawing: 1705 513 001 0
Cross	20488063 20493844
Application	Volvo FH2000 DAF MAN Mercedes

RLD5-Z122	
	Drawing: 1705 514 001 0
Cross	20488061
Application	Volvo
RLD5-Z123	
	Drawing: 1705 515 001 0
Cross	20488058
Application	Volvo
RLD5-Z124	
	Drawing: 1705 516 001 0
Cross	81326200049
Application	MAN
RLD5-Z125	
	Drawing: 1705 517 001 0
Cross	81326200043 81326200039 81326200085
Application	MAN

Shift Knob	
RLD5-Z126	
	Drawing: 1705 518 001 0
Cross	222600045 81326200083
Application	MAN
RLD5-Z127	
	Drawing: 1705 519 001 0
Cross	81326200095
Application	MAN
RLD5-Z128	
	Drawing: 1705 520 001 0
Cross	A4900
Application	Fuller
RLD5-Z129	
	Drawing: 1705 521 001 0
Cross	A5010
Application	Fuller

RLD5-Z130	
	Drawing: 1705 522 001 0
Cross	1727377
Application	Scania
RLD5-Z131	
	Drawing: 1705 523 001 0
Cross	1441235
Application	Scania
RLD5-Z132	
	Drawing: 1705 524 001 0
Cross	A6918
Application	Fuso, Nissan Hino, Isuzu, Mack
RLD5-Z133	
	Drawing: 1705 525 001 0
Cross	174.6933

Shift Knob	
RLD5-Z134	
	Drawing: 1705 526 001 0
Cross	174.6934
RLD5-Z135	
	Drawing: 1705 502 032 0
Cross	A-6918
Application	Fuso Nissan
RLD5-Z136	
	Drawing: 1705 528 001 0
Cross	A7318
Application	Eaton, Fuller
RLD5-Z137	
	Drawing: 1705 529 001 0
Cross	A7315
Application	Eaton, Fuller

	RLD5-Z138	
	Drawing: 1705 530 001 0	
Cross	A7313	
Application	Eaton Fuller	
	RLD5-Z139	
	Drawing: 1705 531 001 0	
Application	Renault	7420915349

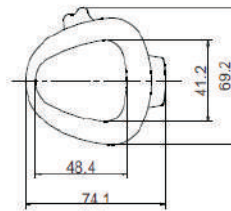
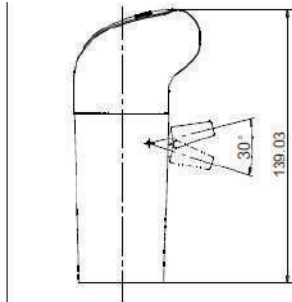
Shift Knob

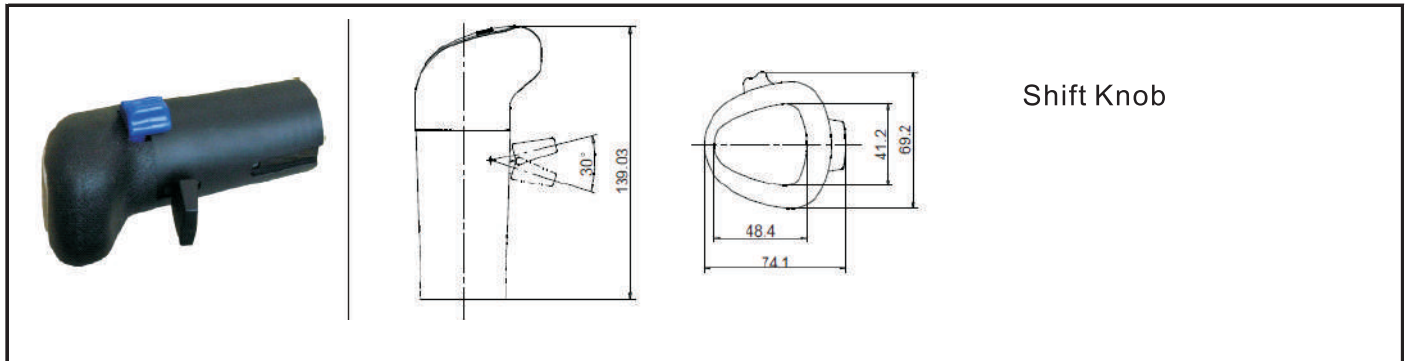

Drawing	Cross	Icon	Remarks
17050020030	1703020AA9K		M12*1.25-7H Red/Blue Fitting
17050020040	1308617300008		M12*1.25-7H Red/Blue Fitting
17050020050	111281700002		M12*1.25-6H Red/Blue Fitting
17050020060 17050020070	1703025-739		M12*1.25-6H Red/Blue Fitting
17050020080	1703020-BQ109		M12*1.25-6H Red/Blue Fitting
17050020090			M12*1.25-6H Red/Blue Fitting
17050020100	1703025-739/B		M12*1.25-7H Red/Blue Fitting
17050020110	1703020-BQ802		M12*1.25-7H Red/Blue Fitting Housing with step profile

Drawing	Cross	Icon	Remarks
17050020120	G0173020011A0		M12*1.75-7H Red/Blue Fitting
17055020150	G0173020030A0		M12*1.75-7H Red/Blue Fitting
17055020160	G0173020043A0		M12*1.75-7H Red/Blue Fitting
17055020170	G0173020045A0		M12*1.75-7H Red/Blue Fitting
17055020180	G0173020039A0		M12*1.75-7H Red/Blue Fitting
17055020190	1703020-BQ509		M12*1.25-7H Red/Blue Fitting
17055020200	1703020-BQ836		M12*1.25-7H Red/Blue Fitting
17055020210	G0173020051A0		M12*1.75-7H Red/Blue Fitting



Shift Knob

Drawing	Cross	Icon	Remarks	Drawing	Cross	Icon	Remarks
17050020220	1703020BJH800		M12*1.25-6H Red/Blue Fitting				
17050020230	G0173020060A0		M12*1.75-6H Red/Blue Fitting				
17050020240	1703040-D649G		M12*1.25-6H Red/Blue Fitting				
17050020250	1073020-810		M12*1.25-6H Red/Blue Fitting				
17050020270	1703020-BQ902		M12*1.25-6H Red/Blue Fitting Housing with step profile				

Water Temperature Meter	
	6491 1101
	Drawing No.: 3808 102 002 0
Cross	003 542 3305
Application	Mercedes
	6491 1503
	Drawing No.: 3808 103 001 0
Application	ST
	6491 1506
	Drawing No.: 3808 104 001 0

Oil Pressure Meter	
	6491 1203
	Drawing No.: 3808 102 001 0
Cross	002 542 1105
Application	Mercedes
	6496 2101
	Drawing No.: 3810 002 002 0
Cross	001 542 9902
Application	Mercedes

	6496 2205
	Drawing No.: 3810 002 003 0
Cross	001 542 4202
Application	Mercedes

Air Pressure Meter	
	6493 1401
	Drawing No.: 3826 008 001 0
	
Cross	RS3.493.401
Application	NLA
	6493 1507
	Drawing No.: 3826 009 001 0
	Operating Pressure Range: 3 bar
Application	NLA

Fuel Meter	
	6496 1102
	Drawing No.: 3806 102 002 0
	
Cross	002 542 9203
Application	Mercedes

Fuel Meter	
	6496 1204
	Drawing No.: 3806 102 003 0
Cross	002 542 9203
Application	Mercedes

	6496 1501
	Drawing No.: 3806 103 001 0
Cross	RS3.496.501

Odometer	
	6492 1216
	Drawing No.: 3802 104 003 0
Cross	007 542 4317
Application	Mercedes

	6492 1220
	Drawing No.: 3802 104 004 0
Application	Mercedes

	6492 1104
	Drawing No.: 3802 104 001 0
Cross	008 542 2206
Application	Mercedes

Tachometer	
	6492 2109
	Drawing No.: 3813 104 001 0
Cross	001 542 8716
Application	Mercedes

	6492 2110
	Drawing No.: 3813 104 002 0
Cross	001 542 4016
Application	Mercedes

	6492 2221
	Drawing No.: 3813 104 004 0
Cross	000 542 9716
Application	Mercedes

Tachometer

6492 2115



Drawing No.: 3813 105 001 0

Cross RS3.492.109A
Application Mercedes

6492 2516



Drawing No.: 3813 108 001 0

Cross RS3.492.109A
Application Mercedes

6492 2413



Drawing No.: 3813 008 001 0

Cross RS3.492.413
Application Mercedes ZS230

6492 2522



Drawing No.: 3813 111 001 0
Voltage: 24V

Cross RS3.492.413
Application Mercedes ZS230

Combination Meter

6489 2110



Drawing No.: 3820 201 002 0
Color: Black

Cross RS3.492.413
Application Mercedes ZS230

Combination Meter

6489 2112

Drawing No.: 3820 201 003 0
Color: Iron Grey
Drawing No.: 3820 201 006 0
Color: Light Grey

Cross 002 540 5847
Application Mercedes

6489 2109



Drawing No.: 3820 201 001 0

Cross RS3.489.109
Application Mercedes

6489 2113



Drawing No.: 3820 203 001 0

Cross RS3.489.110A
Application Mercedes

6489 2213



Drwaing No.: 3820 202 001 0

Cross RS3.489.213
Application Mercedes

Combination Meter

6489 2523



Drawing No.: 3820 204 002 0
Voltage: 24V

6489 2522



Drawing No.: 3820 204 001 0
Voltage: 12V

Panel Assembly

6489 1404



Drawing No.: 3801 003 002 0

Cross 3801010B1-Q126A
Application FAW

6489 1406



Drawing No.: 3801 003 001 0

Cross 3801010-Q422H
Application FAW

6489 1505



Drawing No.: 3801 004 001 0

Cross 3801010-367
Application FAW

6489 1517

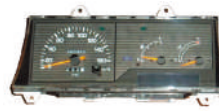

Drawing No.: 3801 010 001 0

Cross RS3.489.517

Water Temperature Sensor

6499 3208



Drawing No.: 3808 211 001 0
Connector Thread: M14x1.5
Operating Temperature Range:
100°C 40±2.5

Cross 002 542 7317
Application Mercedes

6499 3210



Drawing No.: 3808 305 001 0
Connector Thread: M14x1.5
Operating Temperature Range :
100°C 37±3



Cross 001 542 2317
Application Mercedes





6499 3514







Drawing No.: 3808 304 001 0
Connector Thread: M10x1.5
Operating Temperature Range:
200°C 18±2

Cross RS3.499.514

Water Temperature Sensor	
	<p>6499 3515</p> <p>Drawing No.: 3808 404 001 0 Connector Thread: M10x1.5 Operating Temperature Range: 170°C ±3°C</p>
	<p>6499 3516</p> <p>Drawing No.: 3808 212 001 0 Connector Thread: M10x1.5 Operating Temperature Range: 100°C 42±3</p>
Cross	RS3.499.516
	<p>6499 3590</p> <p>Drawing No.: 3808 306 001 0 Connector Thread: M18x1.5 Operating Temperature Range: 98°C ±2°C</p>
	<p>6499 3647</p> <p>Drawing No.: 3808 406 001 0</p>
	<p>6499 3648</p> <p>Drawing No.: 3808 407 001 0</p>
	<p>6499 3649</p> <p>Drawing No.: 3808 408 001 0</p>

Oil Pressure Sensor	
	<p>6499 1110</p> <p>Drawing No.: 3810 202 001 0 Connector Thread: M14x1.5 Operating Pressure Range: 1.5bar</p>
Cross	004542 8917 0301877
Application	Mercedes
	<p>6499 1111</p> <p>Drawing No.: 3810 205 001 0 Connector Thread: Z1/8" Operating Pressure Range: 0~7bar</p>
Cross	RS3.499.1114
Application	Mercedes
	<p>6499 1105</p> <p>Drawing No.: 3810 201 001 0 Connector Thread: M18x1.5 Operating Pressure Range: 0~5bar</p>
Cross	004 542 4317
Application	Mercedes
	<p>6499 1106</p> <p>Drawing No.: 3810 201 002 0 Connector Thread: M18x1.5 Operating Pressure Range: 0~5bar</p>
Application	Mercedes

Oil Pressure Sensor	
	6499 1109 Drawing No.: 3810 301 001 0 Connector Thread: M18x1.5 Operating Pressure Range: 0~16bar
Cross	RS3.499.109
Application	Mercedes
	6499 1407 Drawing No.: 3810 203 004 0 Connector Thread: M12x1.5 Operating Pressure Range: 0~6bar
Cross	RS3.499.115A
Application	Mercedes
	6499 1616 Drawing No.: 3810 202 013 0 Connector Thread: M14x1.5 Operating Pressure Range: 0~6bar
Application	Mercedes

Speed Sensor	
	6499 4634 Drawing No.: 3802 452 001 0 Sensor: 115mm
Application	Iveco

	6499 4635 Drawing No.: 3802 452 002 0 Sensor: 90mm
Application	OEM
	6499 4613 Drawing No.: 3802 204 003 0
	6499 4611 Drawing No.: 3802 601 001 0 Sensor: 25mm
Cross	A013 542 6717
Application	Mercedes
	6499 4215 Drawing No.: 3802 451 001 0 Connector Thread: M22x1.5 Operating Pressure Range: 8/R
Cross	005 542 9417
Application	Mercedes
	6499 4216 Drawing No.: 3802 451 002 0 Connector Thread: M22x1.5 Operating Pressure Range: 8/R
Cross	2159
Application	Mercedes

Speed Sensor	
	<p>6499 4414</p> <p>Drawing No.: 3802 451 004 0 Connector Thread: M22x1.5 Operating-Pressure Range: 8/R</p>
	<p>6499 4422</p> <p>Drawing No.: 3802 207 001 0 Pressure Range: 25/R</p>
	<p>6499 4423</p> <p>Drawing No.: 3802 208 001 0 Pressure Range: 25/R</p>
	<p>RLD5-Z140</p> <p>Drawing No.: 3802 120 001 0</p> <p>Cross OK 43F 55475 OK 72A 5495A</p>
	<p>6499 4555</p> <p>Drawing No.: 3802 202 001 0</p>
	<p>6499 4555A</p> <p>Drawing No.: 3802 202 002 0</p>





	<p>RLD5-Z141</p> <p>Drawing No.: 3802 452 003 0 Installation Thread: M18x1.5 Total/Inductive Length: 75/25 Voltage: 12/24V Sensor: 25mm</p> <p>Cross 012 542 2417 Application Iveco</p>
	<p>RLD5-Z142</p> <p>Drawing No.: 3802 601 006 0 Installation Thread: M18x1.5 Total/Inductive Length: 136.5/90 Voltage: 12/24V Sensor: 43mm</p> <p>Cross 012 542 4617 Application Mercedes</p>
	<p>RLD5-Z143</p> <p>Drawing No.: 3802 452 004 0 Installation Thread: M18x1.5 Total/Inductive Length: 72/20 Voltage: 12/24V Sensor: 20mm</p> <p>Cross 014 542 4117 Application Mercedes</p>
	<p>RLD5-Z144</p> <p>Drawing No.: 3802 601 007 0 Installation Thread: M18x1.5 Total/Inductive Length: 110/63.5 Voltage: 12/24V Sensor: 63mm</p> <p>Cross 0125424717 Application Mercedes</p>

Speed Sensor	
RLD5-Z145	
	Drawing No.: 3802 452 005 0 Installation Thread: M18x1.5 Total/Inductive Length: 113/63 Voltage: 12/24V Sensor: 63mm
Cross	026 542 1317
Application	Mercedes
RLD5-Z146	
	Drawing No.: 3802 601 008 0 Installation Thread: M18x1.5 Total/Inductive Length: 78.5/25 Voltage: 12/24V Sensor: 25mm
Cross	013 542 6217
Application	Mercedes
RLD5-Z147	
	Drawing No.: 3802 123 001 0 Installation Thread: NPT1/8"
RLD5-Z148	
	Drawing No.: 3802 124 001 0 Installation Thread: NPT1/8"





Tachometer Sensor	
6499 5218	
	Drawing No.: 3813 201 001 0 Connector Thread: M22x1.5
Cross	6 003 542 7117
Application	Mercedes



6499 5419	
	Drawing No.: 3813 203 001 0 Connector Thread: M22x1.5
Cross	38 0036 05 001
Application	Mercedes
6499 2584	
	Drawing No.: 3813 013 001 0 Connector Thread: Z1/4" Operating Pressure Range: 0: 025±0: 025Mpa
RLD5-M013	
	Drawing No: 4101 006 001 0 Number of Ports: 2
Cross	A001 545 5809

Brake Light Switch	
6499 2620	
	Drawing No.: 3818 016 001 0
Cross	WA 13255
6499 2621	
	Drawing No.: 3818 017 001 0
Cross	WA 13240

Brake Light Switch	
	6499 2622 Drawing No.: 3818 018 001 0
Cross	WA 13241
	RLD5-Z109 Drawing No: 4101 056 001 0
Cross	BE13250
	RLD5-M018 Drawing No: 4101 037 001 0
Cross	JK611
Application	DongFeng
	RLD5-M019 Drawing No: 4101 038 001 0 Number of Poles: 3 Thread Size M12x1.5 Same as RLD5-Z039
Cross	81.25520.0087 81.25520.0152 70495271
Application	MAN F90/F2000

	RLD5-M022 Drawing No: 4101 039 001 0 Same as RLD5-Z050
Cross	228600
Application	SL-4
	RLD5-M023 Drawing No: 4101 095 001 0 Thread Size M12x1 Fitted Diameter(mm): 12.5 Capacity at 12V: Max170W Capacity at 24V: Max170W Same as RLD5-Z051
Cross	000 545 69 09 0501 208 141
Application	Mercedes
	RLD5-M028 Drawing No: 4101 605 001 0 Number of Ports: 4 Thread Size: M22x1 Same as RLD5-Z088
Cross	81 25520 01/1E 81.25520-0134 81.25520-0171 czm81200171
Application	MAN L2000
	RLD5-M033 Drawing No: 4101 014 001 0 Same as RLD5-Z096

Pressure Switch	
	<p>RLD5-M026</p> <p>Drawing No: 3757 003 001 0 Pressure(bar): 4 Thread Size: NPT 1/4 Same as RLD5-Z087</p> <p>Cross 228750 Application LP-3</p>
	<p>RLD5-M037</p> <p>Drawing No: 4101 049 001 0</p>
	<p>RLD5-M044</p> <p>Drawing No: 3757 003 004 0 Thread Size: NPT1/4-18</p> <p>Application LP-3</p>
	<p>RLD5-M045</p> <p>Drawing No: 3757 003 003 0 Thread Size: NPT1/4-18</p> <p>Cross 276599 Application LP-3</p>
	<p>RLD5-M017</p> <p>Drawing No: 3754 601 001 0</p> <p>Cross 3754030A8E Application CA SERIES FAW</p>

Other Switches	
	<p>6499 2231</p> <p>Drawing No.: 3818 009 001 0</p> <p>Cross A655 545 0008 Application Mercedes</p>
	<p>6499 2418</p> <p>Drawing No.: 3818 009 002 0</p> <p>Cross A667 545 0013 Application Mercedes</p>
	<p>6499 2519</p> <p>Drawing No.: 3818 009 003 0</p> <p>Cross A000 545 9508 Application Mercedes</p>
	<p>RLD5-M020</p> <p>Drawing No: 3758 003 001 0 Same as RLD5-Z040</p> <p>Cross 16100720020 Application Steyr</p>

Other Switches	
RLD5-M021	
	Drawing No: 3757 004 001 0 Same as RLD5-Z046
Cross	36A3D-35001
Application	DongFeng TianLong Mitsubishi
RLD5-M041	
	Drawing No: 4101 099 001 0 Thread Size: NPT1/4-18
Application	81.25937-0040 WABCO D.441 050 1230
RLD5-M042	
	Drawing No: 4101 099 002 0 Thread Size: NPT1/4-18
Cross	4410501000
Application	LP-3 DAF 1365935
RLD5-M043	
	Drawing No: 3813 306 001 0

RLD5-M046	
	Drawing No: 3802 121 001 0
Cross	441 040 015 0
Application	DAF 1450872
RLD5-M047	
	Drawing No: 3802 122 001 0
Cross	441 044 108 0
Application	DAF 1652528
RLD5-M048	
	Drawing No: 3757 001 001 0
Cross	RZ28QK
RLD5-M050	
	Drawing No: 3757 601 005 0 Thread Size: M22x1.5
Cross	3757050-435
Application	FAW

Other Switches	
RLD5-M051	
	Drawing No: 4101 028 003 0 Thread Size: M18x1.5
Cross	3774010-367
Application	FAW
RLD5-M052	
	Drawing No: 4101 019 001 0 Thread Size: M14x1.5
Cross	3729100-116
Application	FAW
RLD5-M053	
	Drawing No: 4101 022 001 0 Thread Size: M14x1.5
Cross	3729100-240
Application	FAW
RLD5-M054	
	Drawing No: 4101 023 001 0 Thread Size: M16x1.5
Cross	3774010-109
Application	FAW

RLD5-M055	
	Drawing No: 1608 101 001 0
Cross	0015429318

INDEX BY SORL PART NUMBERS

SORL No.	Drawing No.	Cross Ref.	Page	SORL No.	Drawing No.	Cross Ref.	Page
6489 1404	3801 003 002 0	3801010B1-Q126A	100	RLD5-A004	3774 004 004 0	6555400045	1
6489 1406	3801 003 001 0	3801010-Q422H	100	RLD5-A005	3774 004 005 0	3575400045	1
6489 1505	3801 004 001 0	3801010-367	100	RLD5-A006	3774 004 006 0	3575400145	1
6489 2109	3820 201 001 0	RS3.489.109	99	RLD5-A007	3774 012 001 0	0055451024	2
6489 2112	3820 201 006 0	0025405847	99	RLD5-A007	3774 012 001 0	0055453824	2
6489 2213	3820 202 001 0	RS3.489.213	99	RLD5-A007	3774 012 001 0	0045454224	2
6489 2522	3820 204 001 0		100	RLD5-A007	3774 012 001 0	0055455124	2
6489 2523	3820 204 002 0		100	RLD5-A007	3774 012 001 0	201918	2
6491 1101	3808 102 002 0	0035423305	97	RLD5-A008	3774 012 002 0	0055455224	2
6491 1203	3808 102 001 0	0025421105	97	RLD5-A008	3774 012 002 0	0045455324	2
6491 1503	3808 103 001 0		97	RLD5-A008	3774 012 002 0	0045451124	2
6491 1506	3808 104 001 0		97	RLD5-A008	3774 012 002 0	45453924	2
6492 1104	3802 104 001 0	0085422206	98	RLD5-A008	3774 012 002 0	91715P	2
6492 1216	3802 104 003 0	0075424317	98	RLD5-A009	3774 012 003 0	0045458124	2
6492 1220	3802 104 004 0		98	RLD5-A010	3774 013 002 0	81.25509.0093	2
6492 2109	3813 104 001 0	0015428716	98	RLD5-A010	3774 013 002 0	81.25509.0124	2
6492 2110	3810 000 000 0	0015424016	98	RLD5-A010	3774 013 002 0	81.25509.0028	2
6492 2221	3813 104 004 0	0005429716	98	RLD5-A010	3774 013 002 0	81.25509.0119	2
6492 2413	3813 008 001 0		99	RLD5-A010	3774 013 002 0	202356	2
6492 2516	3813 108 001 0		99	RLD5-A011	3774 013 001 0	81.25509.9724	2
6492 2522	3813 111 001 0		99	RLD5-A012	3774 024 001 0	0085450124	2
6493 1507	3826 009 001 0		97	RLD5-A013	3774 012 004 0	0065457824	2
6496 1102	3806 102 002 0	0025429203	97	RLD5-A014	3774 044 001 0	0035458724	2
6496 1204	3806 102 003 0	0025429203	98	RLD5-A015	3774 044 002 0	0035458324	3
6496 1501	3806 103 001 0		98	RLD5-A015	3774 044 002 0		3
6496 2101	3810 002 002 0	0015429902	97	RLD5-A015	3774 044 002 0		3
6496 2205	3810 002 003 0	0015424202	97	RLD5-A015	3774 044 002 0	0035458124	3
6499 1105	3810 201 001 0	0045424317	100	RLD5-A016	3774 006 002 0	7332017000	3
6499 1106	3810 201 002 0		100	RLD5-A017	3774 006 001 0	79100580346	3
6499 1109	3810 301 001 0	RS3.499.109	102	RLD5-A017	3774 006 001 0	201259	3
6499 1110	3810 202 001 0	0045428917	100	RLD5-A018	3774 003 001 0		3
6499 1110	3810 202 001 0	0301877	100	RLD5-A019	3774 048 001 0	1594959-1	3
6499 1111	3810 205 001 0	RS3.499.1114	100	RLD5-A019	3774 048 001 0	201563	3
6499 1616	3810 202 013 0		102	RLD5-A020	3774 048 002 0	LS201095	3
6499 2231	3818 009 001 0	A6555450008	106	RLD5-A021	3774 019 001 0	367326	3
6499 2418	3818 009 002 0	A6675450013	106	RLD5-A021	3774 019 001 0	0347893	3
6499 2519	3818 009 003 0	A0005459508	106	RLD5-A021	3774 019 001 0	0301491	3
6499 2584	3813 013 001 0		104	RLD5-A021	3774 019 001 0	0367326	3
6499 2620	3818 016 001 0	WA13255	104	RLD5-A022	3774 022 001 0	20797836	3
6499 2621	3818 017 001 0	WA13240	104	RLD5-A022B	3774 022 002 0	3172170	4
6499 2622	3818 018 001 0	WA13241	105	RLD5-A023	3774 021 001 0	360247	4
6499 3208	3808 211 001 0	0025427317	100	RLD5-A023	3774 021 001 0	201726	4
6499 3210	3808 305 001 0	0015422317	100	RLD5-A024	3774 020 001 0	VB2502802	4
6499 3514	3808 304 001 0	RS3.499.514	100	RLD5-A024	3774 020 001 0	360248	4
6499 3515	3808 404 001 0		100	RLD5-A026	3774 017 001 0	251291	4
6499 3516	3808 212 001 0	RS3.499.516	100	RLD5-A028	3774 046 001 0		4
6499 3590	3808 306 001 0	89422-20010	100	RLD5-A028A	3774 046 002 0		4
6499 3647	3808 406 001 0		100	RLD5-A029	3774 002 001 0	3709010-50	4
6499 3648	3808 407 001 0		100	RLD5-A030	3774 041 005 0	8155750	4
6499 3649	3808 408 001 0		100	RLD5-A030	3774 041 005 0	1578073	4
6499 4215	3802 451 001 0	0055429417	102	RLD5-A030	3774 041 005 0	1587058	4
6499 4216	3802 451 002 0	2159	102	RLD5-A030	3774 041 005 0	1594958	4
6499 4414	3802 201 001 0		103	RLD5-A031	3774 014 001 0		4
6499 4422	3802 207 001 0		103	RLD5-A033	3774 049 001 0	083865039	4
6499 4423	3802 208 001 0		103	RLD5-A033	3774 049 001 0	003545832	4
6499 4555	3802 202 001 0		103	RLD5-A034	3774 050 001 0	2010094	5
6499 4555A	3802 202 002 0		103	RLD5-A037	3774 025 001 0	252490	5
6499 4611	3802 601 001 0	A0135426717	102	RLD5-A040	3774 010 001 0		5
6499 4613	3802 204 003 0		102	RLD5-A041	3774 020 002 0	81255090020	5
6499 4634	3802 452 001 0	115MM	102	RLD5-A041	3774 020 002 0	202024	5
6499 4635	3802 452 002 0		102	RLD5-A042	3774 006 003 0		5
RLD5-A001	3774 004 001 0	6205400045	1	RLD5-A044	3774 026 001 0	81.25509.0013	5
RLD5-A002	3774 004 002 0	6205400145	1	RLD5-A044	3774 026 001 0	01913200	5
RLD5-A003	3774 004 003 0	6555400145	1	RLD5-A045	3774 027 001 0	A0075453624	5

INDEX BY SORL PART NUMBERS

SORL No.	Drawing No.	Cross Ref.	Page	SORL No.	Drawing No.	Cross Ref.	Page
RLD5-A045	3774 027 001 0	81501924	5	RLD5-B008	3741 003 002 0	81.26401.6134	10
RLD5-A045	3774 027 001 0	202641	5	RLD5-B009	3744 004 001 0		13
RLD5-A046	3774 023 001 0	IZ0040IS01	6	RLD5-B010	3741 045 001 0	000824401	10
RLD5-A047	3774 016 001 0	25560-15G05	6	RLD5-B010	3741 045 001 0	402.110,24	10
RLD5-A048	3774 018 001 0	MZ0230IS01	6	RLD5-B012	3741 012 001 0	1585878	9
RLD5-A049	3774 018 002 0	MZ0040IS01	6	RLD5-B012	3741 012 001 0	008693121	9
RLD5-A050	3774 011 001 0	E9362939030	6	RLD5-B015	3741 011 001 0	0008693621	9
RLD5-A051	3774 015 001 0	E9366939090	6	RLD5-B015	3741 011 001 0	008601226	9
RLD5-A052	3774 028 001 0	297.840	5	RLD5-B015	3741 011 001 0	008603226	9
RLD5-A052	3774 028 001 0	LS20099	5	RLD5-B015	3741 011 001 0	81.26485-6016	9
RLD5-A052	3774 028 001 0	200994	5	RLD5-B017	3741 003 005 0		10
RLD5-A052	3774 028 001 0	3645457624	5	RLD5-B018	3741 008 001 0		10
RLD5-A053	3774 025 002 0	252491	5	RLD5-B019	3741 003 006 0		10
RLD5-A054	3774 009 002 0	H07C	6	RLD5-B020	3741 004 001 0		10
RLD5-A055	3774 009 001 0	H07C	6	RLD5-B022	3746 005 004 0	98900-45001	14
RLD5-A055-A	3774 009 003 0		6	RLD5-B023	3746 005 001 0	98900-7300	14
RLD5-A056	3774 013 003 0	HLS203743	6	RLD5-B024	3746 005 002 0		14
RLD5-A057	3774 006 004 0	202624	6	RLD5-B025	3746 004 002 0		14
RLD5-A058	3774 006 005 0	HLS202.345	6	RLD5-B025A	3746 004 001 0		14
RLD5-A060	3774 004 007 0		6	RLD5-B026	3741 006 001 0		10
RLD5-A061	3774 013 004 0		6	RLD5-B027	3741 003 007 0		10
RLD5-A072	3774 039 001 0	1615081	6	RLD5-B028	3741 001 001 0		10
RLD5-A072	3774 039 001 0	1440217	6	RLD5-B029	3741 050 001 0		11
RLD5-A073	3774 012 005 0		6	RLD5-B030	3741 051 001 0		11
RLD5-A081	3774 002 004 0	3735010-240	7	RLD5-B031	3741 005 001 0		11
RLD5-A105	3774 051 001 0	284554500143	7	RLD5-B032	3741 046 001 0		11
RLD5-A106	3774 052 001 0	551154500102	7	RLD5-B033	3741 047 001 0	140	11
RLD5-A107	3774 053 002 0	289654509907	7	RLD5-B034	3741 041 001 0		11
RLD5-A108	3774 054 001 0	283054509909	7	RLD5-B036	3744 005 001 0		13
RLD5-A108A	3774 054 002 0	283054509911	7	RLD5-B037	3741 042 001 0		11
RLD5-A109	3774 002 010 0		7	RLD5-B038	3741 043 001 0		11
RLD5-A110	3774 055 001 0	270254509976	7	RLD5-B039	3741 052 001 0		11
RLD5-A111	3774 057 001 0	284354500101	7	RLD5-B040	3741 048 001 0		11
RLD5-A112	3774 058 001 0	282154500102	8	RLD5-B041	3741 049 001 0		12
RLD5-A119	3774 013 010 0	JK802A	8	RLD5-B042	3744 002 001 0		13
RLD5-A120	3774 002 012 0	3735010EA01/D	8	RLD5-B043	3744 006 001 0	EQ153	13
RLD5-A121	3774 022 002 0	70351744	8	RLD5-B044	3774 007 001 0		13
RLD5-A122	3774 013 021 0	WG9925580102	8	RLD5-B045	3744 008 001 0		13
RLD5-A124	3774 013 020 0	WG9130583117/1	8	RLD5-B046	3744 009 001 0		12
RLD5-A126	3774 004 009 0	5715450124	8	RLD5-B047	3741 008 004 0		12
RLD5-A126A	3774 004 010 0	5715450224	8	RLD5-B048	3744 010 001 0		12
RLD5-B001	3741 055 001 0	854300894300	9	RLD5-B049	3746 012 001 0		14
RLD5-B001	3741 055 001 0	51261017201	9	RLD5-B050	3741 057 001 0		12
RLD5-B001	3741 055 001 0	51261019201	9	RLD5-B050A	3741 057 002 0		12
RLD5-B001	3741 055 001 0	0091540702	9	RLD5-B051	3741 059 001 0		12
RLD5-B001	3741 055 001 0	0120469982	9	RLD5-B052	3741 003 010 0	5188200142	12
RLD5-B001	3741 055 001 0	1020469686	9	RLD5-B053	3741 008 006 0	CV11	12
RLD5-B002	3741 056 001 0	6002026	9	RLD5-B054	3741 050 006 0		12
RLD5-B002	3741 056 001 0	51261017148	9	RLD5-B055	3741 058 001 0	8#	13
RLD5-B002	3741 056 001 0	0051545102	9	RLD5-B056	3741 065 001 0	2404233	13
RLD5-B002	3741 056 001 0	0120489728	9	RLD5-C001	5205 037 003 0	381.8000141	14
RLD5-B003	3741 010 001 0	81.26485.6030	9	RLD5-C002	5205 037 002 0	3818200241	14
RLD5-B004	3741 009 002 0	0018241501	9	RLD5-C003	5205 039 001 0		14
RLD5-B005	3741 009 001 0	3818240301	9	RLD5-C004	5205 033 001 0	81.26411.6089	15
RLD5-B005	3741 009 001 0	3818244810	9	RLD5-C005	5205 042 001 0		15
RLD5-B006	3741 003 001 0	402308	9	RLD5-C006	5205 035 001 0		15
RLD5-B006	3741 003 001 0	0028203042	9	RLD5-C009	5205 510 003 0		19
RLD5-B006	3741 003 001 0	0038202742	9	RLD5-C010	5205 511 003 0	022	19
RLD5-B006	3741 003 001 0	0048206742	9	RLD5-C011	5205 509 003 0	023	19
RLD5-B006	3741 003 001 0	0038205042	9	RLD5-C012	5205 512 003 0		20
RLD5-B006	3741 003 001 0	403071	9	RLD5-C013	5205 504 005 0		20
RLD5-B006	3741 003 001 0	403873	9	RLD5-C014	5205 031 002 0		15
RLD5-B006	3741 003 001 0	406629	9	RLD5-C015	5205 500 003 0		20
RLD5-B006	3741 003 001 0	407071	9	RLD5-C019	5205 043 001 0	E9402850447	15

INDEX BY SORL PART NUMBERS

SORL No.	Drawing No.	Cross Ref.	Page	SORL No.	Drawing No.	Cross Ref.	Page
RLD5-C020	5205 002 001 0	E9362930012	15	RLD5-C212C	5206 515 004 0		22
RLD5-C022	5205 507 001 0		21	RLD5-C213	5205 516 001 0		22
RLD5-C024	5205 033 002 0	81.26411.6090	15	RLD5-C213A	5205 516 002 0		22
RLD5-C025	5205 015 001 0		15	RLD5-C213B	5205 516 003 0		22
RLD5-C026	5205 005 001 0	TA0200WL01	15	RLD5-C214	5205 517 001 0		22
RLD5-C027	5205 006 001 0		15	RLD5-C214A	5205 516 002 0		22
RLD5-C028	5205 007 001 0	TA0100WL01	16	RLD5-C214B	5205 517 003 0		22
RLD5-C029	5205 008 001 0	TA0540WL01	16	RLD5-C215	5205 518 001 0		22
RLD5-C030	5205 004 001 0	NN0320WL01	16	RLD5-C215A	5205 518 002 0		22
RLD5-C031	5205 011 001 0	TA0400WL01	16	RLD5-C215B	5205 518 003 0		22
RLD5-C032	5205 012 001 0	IZ0040WL01	16	RLD5-C216A	5205 519 001 0		22
RLD5-C033	5205 003 001 0	IZ0080WL01	16	RLD5-C216B	5205 519 002 0		23
RLD5-C034	5205 010 001 0	NN0100WL01	16	RLD5-C216C	5205 519 003 0		23
RLD5-C035	5205 013 001 0	TA0530WL01	16	RLD5-C216D	5205 519 004 0		23
RLD5-C036	5205 009 001 0	NN0310WL01	16	RLD5-C216E	5205 519 005 0		23
RLD5-C037	5205 014 001 0	TA0360WL01	16	RLD5-C217A	5205 520 001 0		23
RLD5-C040	5205 509 002 0		19	RLD5-C217B	5205 520 002 0		23
RLD5-C042	5205 504 004 0		20	RLD5-C218A	5205 521 001 0		23
RLD5-C044	5205 502 004 0		20	RLD5-C218B	5205 521 002 0		23
RLD5-C047	5205 500 002 0		20	RLD5-C218C	5205 521 003 0		23
RLD5-C048	5205 506 001 0		21	RLD5-C218D	5205 521 004 0		23
RLD5-C053	5205 502 005 0	81.26430.0113	20	RLD5-C218E	5205 521 005 0		23
RLD5-C053	5205 502 013 0	81.26430.0083	20	RLD5-D001	3736 001 004 0	37AD-35010	24
RLD5-C080	5205 025 001 0	MZ0130WL01	17	RLD5-D002	3703 001 001 0	034130021	25
RLD5-C081	5205 024 001 0	MZ035WL01	17	RLD5-D002	3703 001 001 0	99100760100	25
RLD5-C082	5205 020 001 0	MI0090WL01	17	RLD5-D003	3703 001 004 0	3736010-X160	25
RLD5-C083	5205 028 001 0	TA00F0WL01	17	RLD5-D006	3703 003 001 0	RM-05605	25
RLD5-C084	5205 019 001 0	MI0100WL01	17	RLD5-D007	3703 004 001 0	08010100	25
RLD5-C085	5205 022 001 0	MZ0040ML01	17	RLD5-D007	3703 004 001 0	341915060	25
RLD5-C086	5205 027 001 0	TA0260WL01	17	RLD5-D008	3736 007 001 0	443815432020	25
RLD5-C087	5205 023 001 0	MZ0150ML01	17	RLD5-D008	3736 007 001 0	E9341915061	25
RLD5-C088	5205 021 001 0	NN0390WL01	17	RLD5-D009	3736 006 002 0	0341002003	25
RLD5-C089	5205 026 001 0	NN03F0WL01	17	RLD5-D009	3736 006 002 0	1587698	25
RLD5-C090	5205 029 001 0		18	RLD5-D009	3736 006 002 0	240315	25
RLD5-C092	5205 001 002 0		18	RLD5-D009	3736 006 002 0	3987034	25
RLD5-C094	5205 034 001 0		18	RLD5-D010	3736 015 001 0	02-9432.00	26
RLD5-C101	5205 044 001 0		18	RLD5-D011	3736 006 001 0	0005452508	26
RLD5-C102	5205 045 001 0		18	RLD5-D011	3736 006 001 0	0005458408	26
RLD5-C103	5205 046 001 0		18	RLD5-D011	3736 006 001 0	621730	26
RLD5-C104	5205 047 001 0		18	RLD5-D011	3736 006 001 0	6EK001559001	26
RLD5-C105	5205 048 001 0	6820	18	RLD5-D011	3736 006 001 0	6EK001559-007	26
RLD5-C106	5205 049 001 0	ZK6739.1550	18	RLD5-D012	3736 009 001 0	B-193697	26
RLD5-C107	5205 058 001 0		19	RLD5-D013	3703 001 008 0	3736020-X160A	26
RLD5-C108	5205 057 001 0		19	RLD5-D014	3736 001 001 0	3736010-Q53	24
RLD5-C109	5205 059 001 0		19	RLD5-D015	3736 011 002 0		24
RLD5-C201	5205 508 001 0		19	RLD5-D016	3736 014 001 0		24
RLD5-C202	5205 509 001 0		19	RLD5-D017	3736 011 001 0		24
RLD5-C203	5205 510 001 0		19	RLD5-D017A	3736 011 002 0		24
RLD5-C204	5205 511 001 0		19	RLD5-D018	3736 001 013 0	D240A	24
RLD5-C205	5205 512 001 0		20	RLD5-D019	3736 013 006 0		24
RLD5-C206	5205 504 004 0		20	RLD5-D020	3736 012 001 0		25
RLD5-C207	5205 502 001 0		20	RLD5-D021	3736 013 001 0		25
RLD5-C208	5205 500 001 0		20	RLD5-D022	3703 002 001 0	820.000.000	26
RLD5-C209	5205 503 001 0		21	RLD5-D023	3736 005 001 0		26
RLD5-C210	5205 513 001 0		21	RLD5-D024	3703 005 001 0	37ZB1-36010	26
RLD5-C210A	5205 513 002 0		21	RLD5-D025	3736 007 003 0		26
RLD5-C211	5205 514 001 0		21	RLD5-D026	3736 006 003 0	21568629	26
RLD5-C211A	5205 514 002 0		21	RLD5-D027	3703 001 015 0	3736020-DL02A	27
RLD5-C211B	5205 514 003 0	108.914	21	RLD5-D028	3703 003 002 0	WG9725764001	27
RLD5-C211B	5205 514 003 0	466	21	RLD5-D029	3703 003 003 0		27
RLD5-C211B	5205 514 003 0	8189632	21	RLD5-D030	3736 017 001 0	3722080-382	27
RLD5-C212	5205 515 001 0		21	RLD5-D030	3736 007 002 0	443815432020-B	27
RLD5-C212A	5205 515 002 0		21	RLD5-D030A	3736 017 003 0	3722080-50A	27
RLD5-C212B	5205 515 003 0		21	RLD5-E001	3704 016 001 0		28

INDEX BY SORL PART NUMBERS

SORL No.	Drawing No.	Cross Ref.	Page	SORL No.	Drawing No.	Cross Ref.	Page
RLD5-E002	3704 003 001 0	0014621130	28	RLD5-F003A	3730 004 002 0		31
RLD5-E002	3704 003 001 0	3504607004	28	RLD5-F003B	3730 004 003 0		31
RLD5-E003	3704 016 003 0		28	RLD5-F004	3730 011 001 0		31
RLD5-E005	3704 010 001 0		28	RLD5-F004A	3730 011 002 0		31
RLD5-E006	3704 009 001 0	130009	28	RLD5-F004B	3730 011 003 0		32
RLD5-E006	3704 009 001 0	0005453013	28	RLD5-F005	3730 001 002 0		32
RLD5-E006	3704 009 001 0	960829	28	RLD5-F005A	3730 012 001 0		32
RLD5-E007	3704 018 001 0	0342106005	28	RLD5-F006	3730 013 001 0		32
RLD5-E008	3704 202 003 0	361552MN1247	28	RLD5-F006A	3730 013 002 0		32
RLD5-E008	3704 202 003 0	81.46433.6006	28	RLD5-F006B	3730 013 003 0		32
RLD5-E008	3704 202 003 0	81971006034	28	RLD5-F007	3730 014 001 0		32
RLD5-E010	3704 002 002 0	0005458308	28	RLD5-F007A	3730 014 002 0		32
RLD5-E010	3704 002 002 0	0342309008	28	RLD5-F007B	3730 014 003 0		32
RLD5-E010	3704 002 002 0	0502877	28	RLD5-F008	3730 015 001 0		33
RLD5-E010	3704 002 002 0	1716022	28	RLD5-F008A	3730 015 002 0		33
RLD5-E010	3704 002 002 0	276560340	28	RLD5-F008B	3730 015 003 0		33
RLD5-E010	3704 002 002 0	5755065	28	RLD5-F009	3730 016 001 0		33
RLD5-E010	3704 002 002 0	81255016030	28	RLD5-F009A	3730 016 002 0		33
RLD5-E011	3704 002 003 0	0342309006	29	RLD5-F009B	3730 016 003 0		33
RLD5-E012	3704 002 004 0	0005453013	29	RLD5-F010	3730 017 001 0		32
RLD5-E012	3704 002 004 0	0142001	29	RLD5-F010A	3730 017 002 0		32
RLD5-E012	3704 002 004 0	02482029	29	RLD5-F011	3730 018 001 0		32
RLD5-E012	3704 002 004 0	0302238	29	RLD5-F011A	3730 018 002 0		32
RLD5-E012	3704 002 004 0	O302319	29	RLD5-F011B	3730 018 003 0		32
RLD5-E012	3704 002 004 0	0342309004	29	RLD5-F012	3730 024 001 0		33
RLD5-E012	3704 002 004 0	0342106005	29	RLD5-F013	3730 025 001 0		33
RLD5-E012	3704 002 004 0	0342106009	29	RLD5-F014	3730 026 001 0		33
RLD5-E012	3704 002 004 0	1139129712	29	RLD5-F015	3730 027 001 0		33
RLD5-E012	3704 002 004 0	1716013	29	RLD5-F016	3730 028 001 0		33
RLD5-E012	3704 002 004 0	3031673	29	RLD5-F017	3730 029 001 0		34
RLD5-E012	3704 002 004 0	490102	29	RLD5-F017A	3730 029 001 0		34
RLD5-E012	3704 002 004 0	81255016005	29	RLD5-F017B	3730 029 001 0		34
RLD5-E012	3704 002 004 0	90816130129	29	RLD5-F018	3730 030 001 0		32
RLD5-E013	3704 011 001 0	FT00101KS01	29	RLD5-G007	3722 002 001 0	5005458401	34
RLD5-E015	3704 001 001 0	02910770	29	RLD5-G008	3722 002 004 0	0005458401	34
RLD5-E016	3704 012 001 0	45020-12-11	29	RLD5-G008	3722 002 004 0		34
RLD5-E016	3704 012 001 0	TA0100KS01	29	RLD5-G009	3722 002 005 0	0005458501	34
RLD5-E017	3704 019 001 0		29	RLD5-G009	3722 002 005 0	5005458401	34
RLD5-E018	3704 002 001 0	59000580048	29	RLD5-G010	3735 020 001 0		66
RLD5-E019	3704 017 001 0	3708010	29	RLD5-G012	3722 001 001 0	5005455001	34
RLD5-E024	3704 012 002 0	45020-12-6	28	RLD5-G012	3722 001 001 0	79100580021	34
RLD5-E024	3704 012 002 0	TA0080KS02	28	RLD5-G016	3722 014 001 0	0025450734	36
RLD5-E025	3704 301 001 0	371910	29	RLD5-G016	3722 014 001 0	0025450834	36
RLD5-E025	3704 301 001 0	1.21087	29	RLD5-G016	3722 014 001 0	0025450934	36
RLD5-E026	3704 302 001 0	81255016033	30	RLD5-G016	3722 014 001 0	0025451034	36
RLD5-E027	3704 300 001 0	0005458108	30	RLD5-G016	3722 014 001 0	0025451234	36
RLD5-E028	3704 401 001 0	0005455413	30	RLD5-G017	3722 015 001 0		36
RLD5-E028	3704 401 001 0	4.61015	30	RLD5-G019	3722 001 001 0	TA0360DB00	35
RLD5-E031	3704 003 001 0	6554620030	30	RLD5-G020	3722 004 002 0	SL1009EL	35
RLD5-E031	3704 003 001 0	6504620030	30	RLD5-G021	3722 005 002 0	TA0600DB00	35
RLD5-E033	3704 023 001 0	513000LOT120753	30	RLD5-G022	3722 009 001 0		35
RLD5-E034	3704 024 001 0	3704110-Q435	30	RLD5-G023	3722 010 001 0	SL1009EL	35
RLD5-E035	3704 402 001 0		30	RLD5-G024	3722 011 001 0		35
RLD5-F001	3730 009 001 0		31	RLD5-G025	3722 008 001 0	179100580024	35
RLD5-F001A	3730 009 002 0		31	RLD5-G026	3722 008 002 0	179100580025	35
RLD5-F001B	3730 009 003 0		31	RLD5-G027	3722 006 001 0	TA0080DB01	36
RLD5-F002	3730 010 001 0		31	RLD5-G028	3722 013 001 0		36
RLD5-F002A	3730 010 002 0		31	RLD5-G029	3722 012 001 0		36
RLD5-F002B	3730 010 003 0		31	RLD5-G030	3722 007 001 0		36
RLD5-F003	3730 004 001 0	0065450626	31	RLD5-G031	3722 017 008 8		36
RLD5-F003	3730 004 001 0	1301750	31	RLD5-G032	3722 017 001 0		36
RLD5-F003	3730 004 001 0	0015450626	31	RLD5-G033	3722 018 001 0		36
RLD5-F003	3730 004 001 0	8JA003831001	31	RLD5-G034	3722 018 002 0		36
RLD5-F003	3730 004 001 0	8JB003833001	31	RLD5-H001	3735 049 001 0	1337453	37

INDEX BY SORL PART NUMBERS

SORL No.	Drawing No.	Cross Ref.	Page	SORL No.	Drawing No.	Cross Ref.	Page
RLD5-H001	3735 049 001 0	A0011522410	37	RLD5-I010-03	3792 006 009 0		45
RLD5-H002	3735 050 001 0	A0011523210	37	RLD5-I010-04	3792 006 011 0		46
RLD5-H003	3735 002 001 0		37	RLD5-I010-05	3792 006 002 0		46
RLD5-H004	3735 039 001 0		37	RLD5-I010-05	3792 006 002 0		46
RLD5-H005	3735 040 001 0		37	RLD5-I010-06	3792 006 006 0		46
RLD5-H006	3735 041 001 0		37	RLD5-I010-07	3792 006 008 0		46
RLD5-H007	3735 042 001 0		37	RLD5-I010-08	3792 006 005 0		46
RLD5-H008	3735 043 001 0		37	RLD5-I010-09	3792 006 007 0		46
RLD5-H009	3735 044 001 0		37	RLD5-I010-10	3792 006 003 0		46
RLD5-H010	3735 045 001 0		37	RLD5-I010-11	3792 006 004 0		46
RLD5-H011	3735 046 001 0		37	RLD5-I019	3790 006 001 0	5145450124	42
RLD5-H012	3735 047 001 0		38	RLD5-I021-01	3792 026 014 0		46
RLD5-H013	3735 048 001 0		38	RLD5-I021-02	3792 026 001 0		46
RLD5-H014	3735 003 001 0		38	RLD5-I021-03	3792 026 002 0		46
RLD5-H015	3735 003 002 0		38	RLD5-I021-04	3792 026 004 0		46
RLD5-H016	3735 003 003 0		38	RLD5-I021-05	3792 026 009 0		46
RLD5-H017	3735 003 004 0		38	RLD5-I021-06	3792 026 015 0		46
RLD5-H018	3735 003 005 0		38	RLD5-I021-07	3792 026 012 0		46
RLD5-H019	3735 003 006 0		38	RLD5-I021-08	3792 026 013 0		46
RLD5-I001	3792 001 001 0	1578704	39	RLD5-I021-09	3792 026 008 0		47
RLD5-I002	3792 001 002 0	1578702	39	RLD5-I021-10	3792 026 008 0		47
RLD5-I003	3792 001 003 0	1578700-5	39	RLD5-I021-11	3792 026 016 0		47
RLD5-I004	3792 002 013 0	0025452407	51	RLD5-I021-12	3792 026 006 0		47
RLD5-I004	3792 002 013 0	25452407	51	RLD5-I021-12	3792 026 006 0		47
RLD5-I004-01	3792 002 033 0	5215455090	51	RLD5-I021-13	3792 026 017 0		47
RLD5-I004-02	3792 002 008 0		51	RLD5-I021-14	3792 026 018 0		47
RLD5-I004-03	3792 002 009 0	5215455290	51	RLD5-I021-15	3792 026 019 0		47
RLD5-I004-04	3792 002 009 0	0085457590	51	RLD5-I028	3792 027 001 0	0008209010	39
RLD5-I004-05	3792 002 044 0	0065452990	51	RLD5-I029	3792 019 001 0	1248200110	39
RLD5-I004-06	3792 002 030 0	0035457990	51	RLD5-I030	3792 012 001 0	37AD-68010	39
RLD5-I004-07	3792 002 035 0	0055458690	51	RLD5-I031	3792 015 001 0		39
RLD5-I004-08	3792 002 036 0	5215455190	51	RLD5-I032	3790 008 002 0	37AD-46040	42
RLD5-I004-09	3792 002 005 0		51	RLD5-I033	3790 008 001 0	37AD-46030	42
RLD5-I004-10	3792 002 006 0		51	RLD5-I034	3792 018 001 0	37AD-89012	42
RLD5-I004-11	3792 002 007 0		51	RLD5-I036-01	3792 024 023 0		47
RLD5-I004-12	3792 002 034 0	0035459390	51	RLD5-I036-02	3792 024 003 0		47
RLD5-I004-13	3792 002 031 0	5005453390	51	RLD5-I036-03	3792 024 024 0		47
RLD5-I004-14	3792 002 042 0	5115455090	51	RLD5-I036-04	3792 024 010 0		47
RLD5-I004-15	3792 002 043 0	5005455490	51	RLD5-I036-05	3792 024 009 0		47
RLD5-I004-16	3792 002 053 0	5135450190	51	RLD5-I036-06	3792 024 025 0		47
RLD5-I004-17	3792 002 051 0	5005459290	51	RLD5-I036-07	3792 024 007 0		47
RLD5-I004-18	3792 002 056 0	5205450190	51	RLD5-I036-08	3792 024 005 0		48
RLD5-I004-19	3792 002 054 0		51	RLD5-I036-09	3792 024 002 0		48
RLD5-I004-20	3792 002 055 0	5205450290	51	RLD5-I036-10	3792 024 001 0		48
RLD5-I004-21	3792 002 057 0	5205450490	51	RLD5-I036-11	3792 024 026 0		48
RLD5-I004-22	3792 002 058 0	5205450590	51	RLD5-I036-12	3792 024 027 0		48
RLD5-I004-23	3792 002 050 0	5005429190	51	RLD5-I036-13	3792 024 028 0		48
RLD5-I004-24	3792 002 049 0	5215455390	51	RLD5-I036-14	3792 024 029 0		48
RLD5-I004-25	3792 002 045 0	5095454390	51	RLD5-I036-15	3792 024 030 0		48
RLD5-I004-25	3792 002 048 0	5095454290	51	RLD5-I036-16	3792 024 031 0		48
RLD5-I004-25	3792 002 047 0	5095454490	51	RLD5-I036-17	3792 024 004 0		48
RLD5-I007-01	3792 003 001 0	0055459224	45	RLD5-I037	3792 010 001 0	43241	39
RLD5-I007-02	3792 003 002 0	5095459124	45	RLD5-I049	3792 036 007 0	81.25505.6302	41
RLD5-I007-03	3792 003 003 0	5645459324	45	RLD5-I051	3792 011 001 0	81.25907.0225	44
RLD5-I007-04	3792 003 004 0	5115459324	45	RLD5-I052-01	3792 017 001 0		48
RLD5-I007-05	3792 003 005 0	5115459524	45	RLD5-I052-02	3792 017 009 0		48
RLD5-I007-06	3792 003 006 0	5115459624	45	RLD5-I052-03	3792 017 008 0		48
RLD5-I007-07	3792 003 007 0	5115459424	45	RLD5-I052-04	3972 017 003 0		48
RLD5-I007-08	3792 003 008 0	5215459424	45	RLD5-I052-05	3792 017 006 0		49
RLD5-I007-09	3792 003 009 0	5865459224	45	RLD5-I052-06	3792 017 013 0		49
RLD5-I007-10	3792 003 010 0		45	RLD5-I052-07	3792 017 014 0		49
RLD5-I007-11	3792 003 011 0		45	RLD5-I052-08	3792 017 002 0		49
RLD5-I010-01	3792 006 001 0		45	RLD5-I052-09	3792 017 005 0		49
RLD5-I010-02	3792 006 010 0		45	RLD5-I052-10	3792 017 011 0		49

INDEX BY SORL PART NUMBERS

SORL No.	Drawing No.	Cross Ref.	Page	SORL No.	Drawing No.	Cross Ref.	Page
RLD5-I052-11	3792 017 004 0		49	RLD5-I079-16	3790 000 000 0		53
RLD5-I052-12	3792 017 012 0		49	RLD5-I079-17	3792 052 044 0		53
RLD5-I052-13	3792 017 010 0		49	RLD5-I079-18	3792 052 045 0		53
RLD5-I052-14	3792 017 007 0		49	RLD5-I079-19	3792 052 046 0		53
RLD5-I053-01	3792 020 005 0	93662-Y4010G	52	RLD5-I079-20	3792 052 047 0		53
RLD5-I053-02	3792 020 001 0	93727-Y4010G	52	RLD5-I079-21	3792 052 048 0		53
RLD5-I053-03	3792 020 003 0	93763-7A000	52	RLD5-I079-22	3792 052 049 0		53
RLD5-I053-04	3792 020 004 0	93762-Y4010G	52	RLD5-I079-23	3792 052 050 0		53
RLD5-I053-05	3792 020 002 0	93761-Y4010G	52	RLD5-I079-24	3792 052 051 0		53
RLD5-I053-06	3792 020 006 0	93762-7A000	52	RLD5-I079-25	3792 052 052 0		53
RLD5-I054-01	4102 001 001 0	93740-V1030	52	RLD5-I079-26	3792 052 053 0		53
RLD5-I054-02	4102 001 002 0	93730-V1030	52	RLD5-I079-27	3792 052 054 0		53
RLD5-I054-03	4102 002 001 0	93375-V1030	52	RLD5-I079-28	3792 052 055 0		53
RLD5-I054-04	4102 003 001 0	93620-V1030	52	RLD5-I079-29	3792 052 056 0		53
RLD5-I054-05	4102 004 001 0	93710-V1030	52	RLD5-I079-30	3792 052 057 0		53
RLD5-I055	3790 002 001 0	0045450207	42	RLD5-I080-01	3792 022 002 0		54
RLD5-I055-01	3792 505 001 0	93375-V3310	52	RLD5-I080-02	3792 022 017 0		54
RLD5-I055-02	3792 505 005 0	93360-V3860	52	RLD5-I080-03	3792 022 019 0		54
RLD5-I056	3792 032 001 0	353628	41	RLD5-I080-04	3792 022 003 0		54
RLD5-I056-01	3792 001 007 0	179100580187	49	RLD5-I080-05	3792 022 021 0		54
RLD5-I056-02	3792 001 008 0	179100580062	49	RLD5-I080-06	3792 022 011 0		54
RLD5-I056-03	3792 001 006 0	179100580076	49	RLD5-I080-07	3792 022 008 0		54
RLD5-I056-04	3792 001 009 0	179100580101	49	RLD5-I080-08	3792 022 009 0		54
RLD5-I056-05	3792 001 010 0	179100580068	50	RLD5-I080-09	3792 022 004 0		54
RLD5-I056-06	3792 001 011 0	1.79101E+11	50	RLD5-I080-10	3792 022 018 0		54
RLD5-I056-07	3792 001 012 0	179100580070	50	RLD5-I080-11	3792 022 012 0		54
RLD5-I056-08	3792 001 013 0	179100580071	50	RLD5-I080-12	3792 022 023 0		54
RLD5-I056-09	3792 001 005 0	179100580060	50	RLD5-I080-13	3792 022 005 0		54
RLD5-I056-10	3792 001 004 0	179100580059	50	RLD5-I080-14	3792 022 016 0		54
RLD5-I056-11	3792 001 014 0		50	RLD5-I080-15	3792 022 020 0		54
RLD5-I056-12	3792 001 015 0		50	RLD5-I080-16	3792 022 024 0		54
RLD5-I057	3790 002 002 0	0075456417	41	RLD5-I080-17	3792 022 013 0		54
RLD5-I058	3746 001 002 0	A0035452013	42	RLD5-I080-18	3792 022 022 0		54
RLD5-I059	3746 001 001 0	A0035455113	43	RLD5-I080-19	3792 022 025 0		54
RLD5-I065	3746 010 001 0	10318809	43	RLD5-I080-20	3792 022 015 0		54
RLD5-I066	3746 021 001 0	10221254	43	RLD5-I080-21	3792 022 007 0		54
RLD5-I067	3746 011 001 0	12135165	43	RLD5-I080-22	3792 022 010 0		54
RLD5-I068	3746 012 001 0	15590707	43	RLD5-I080-23	3792 022 001 0		54
RLD5-I069	3790 012 002 0	15590708	43	RLD5-I080-24	3792 022 014 0		54
RLD5-I070	3790 012 003 0	15602610	43	RLD5-I080-25	3792 022 006 0		54
RLD5-I071	4101 608 001 0	25558081	43	RLD5-I080-26	3792 022 026 0		54
RLD5-I072	3792 047 001 0	554454500401	42	RLD5-I080-27	3792 022 027 0		54
RLD5-I074	3792 051 001 0	284554500111	42	RLD5-I080-28	3792 022 028 0		54
RLD5-I075	3792 003 013 0	6115400066	41	RLD5-I080-29	3792 022 029 0		54
RLD5-I076	3746 013 001 0	269954510163	44	RLD5-I080-30	3792 022 030 0		54
RLD5-I077	3746 014 001 0	282354500102	44	RLD5-I080-31	3792 022 031 0		54
RLD5-I078	3746 015 001 0	269954510164	44	RLD5-I080-32	3792 022 032 0		54
RLD5-I079-01	3792 029 014 0		53	RLD5-I080-33	3792 022 033 0		54
RLD5-I079-02	3792 029 015 0		53	RLD5-I081	3746 001 003 0	000947	44
RLD5-I079-03	3792 052 030 0		53	RLD5-I081	3746 001 003 0	A0045454713	44
RLD5-I079-04	3792 052 031 0		53	RLD5-I082	3746 001 004 0	0065252	44
RLD5-I079-04	3790 000 000 0		53	RLD5-I082	3746 001 004 0	A0045450113	44
RLD5-I079-05	3792 052 032 0		53	RLD5-J001	3787 015 001 0	3817230301	55
RLD5-I079-06	3792 052 033 0		53	RLD5-J001A	3787 015 002 0	3817230001	55
RLD5-I079-07	3792 052 034 0		53	RLD5-J002	3789 004 001 0	6417200246	55
RLD5-I079-08	3792 052 035 0		53	RLD5-J003	3789 004 002 0	6417200346	55
RLD5-I079-09	3792 052 036 0		53	RLD5-J004	3787 010 001 0		56
RLD5-I079-10	3792 052 037 0		53	RLD5-J004A	3787 010 001 0	3814660901	56
RLD5-I079-11	3792 052 038 0		53	RLD5-J004A	3787 010 001 0	3817660901	56
RLD5-I079-12	3792 052 039 0		53	RLD5-J004A	3787 010 001 0	3817600259	56
RLD5-I079-13	3792 052 040 0		53	RLD5-J004A	3787 010 001 0	6317601259	56
RLD5-I079-14	3792 052 041 0		53	RLD5-J004A	3787 010 001 0	6707600159	56
RLD5-I079-15	3792 052 042 0		53	RLD5-J005	3787 009 001 0		56
RLD5-I079-16	3792 052 043 0		53	RLD5-J005A	3787 009 002 0	3227660701	57

INDEX BY SORL PART NUMBERS

SORL No.	Drawing No.	Cross Ref.	Page	SORL No.	Drawing No.	Cross Ref.	Page
RLD5-J005A	3787 009 002 0	460516	57	RLD5-K043	3766 034 001 0	81980-22060	60
RLD5-J006	3787 008 001 0		57	RLD5-K043	3766 034 001 0	81980-22070	60
RLD5-J006A	3787 008 002 0	12017.0159	57	RLD5-K043	3766 034 001 0	81980-36010	60
RLD5-J009	3787 011 001 0	6417600259	57	RLD5-K043	3766 034 001 0	81980-36040	60
RLD5-J009A	3787 011 002 0	6417600359	57	RLD5-K043	3766 034 001 0	81980-36060	60
RLD5-J016	3789 003 001 0	3227250202	55	RLD5-K044	3766 035 001 0	MC-843788	65
RLD5-J017	3789 003 002 0	3227250302	55	RLD5-K045	3766 036 002 0		65
RLD5-J018	3789 005 001 0	3T361989040	56	RLD5-K045A	3766 036 001 0		65
RLD5-J019	3789 017 001 0		55	RLD5-K046	3766 037 002 0		65
RLD5-J020	3787 013 001 0		55	RLD5-K046A	3766 037 001 0		65
RLD5-J020A	3787 013 002 0		55	RLD5-K047	3766 021 001 0	1B24937500031	60
RLD5-J021	3787 012 001 0		57	RLD5-K048	3766 038 002 0	0015421119	65
RLD5-J021A	3787 012 002 0		57	RLD5-K048A	3766 038 001 0		65
RLD5-J023	3789 010 001 0		56	RLD5-K049	3766 026 001 0	SG254B	60
RLD5-J023A	3787 010 002 0		56	RLD5-K049A	3766 026 002 0		60
RLD5-J024	3789 002 001 0		56	RLD5-K050	3766 026 003 0	SG254C	60
RLD5-J024A	3787 002 002 0		56	RLD5-K050A	3766 026 004 0	SG254C	60
RLD5-K001	3766 020 001 0	4DW004356-00	58	RLD5-K051	3766 008 001 0	81253110005	60
RLD5-K002	3766 007 001 0	068500-2900	58	RLD5-K051	3766 008 001 0	81253110009	60
RLD5-K002A	3766 007 002 0	36ADQ-40020	58	RLD5-K051	3766 008 001 0	81253110012	60
RLD5-K003	3766 019 001 0	4DW004834-12	58	RLD5-K051	3766 008 001 0	81253110024	60
RLD5-K004	3766 027 001 0	4DM001863-08	58	RLD5-K051	3766 008 001 0	81253110025	60
RLD5-K005	3766 022 001 0	1B24937500031	58	RLD5-K051	3766 008 001 0	81253110027	60
RLD5-K006	3735 027 001 0	1B24937500006	61	RLD5-K051A	3766 008 002 0	81253110006	60
RLD5-K007	3735 028 001 0	4RA0035100814P	64	RLD5-K051A	3766 008 002 0	81253110010	60
RLD5-K008	3735 029 001 0	3741060-240	61	RLD5-K051A	3766 008 002 0	81253110013	60
RLD5-K009	3735 030 001 0	1B24937500004	61	RLD5-K051A	3766 008 002 0	81253110026	60
RLD5-K010	3735 031 001 0	3818080-240	62	RLD5-K051A	3766 008 002 0	81253110028	60
RLD5-K012	3766 028 001 0	3801-16510	62	RLD5-K052	3735 009 001 0	81253110023	62
RLD5-K013	3766 029 001 0	1B24937500002	62	RLD5-K053	3735 038 001 0	0035458105	65
RLD5-K014	3766 004 001 0	3726030-50	58	RLD5-K062	3766 005 001 0		61
RLD5-K015	3766 002 001 0	79100580160	58	RLD5-K063	3766 001 001 0	0035445332	61
RLD5-K016	3735 016 001 0	3801-16140	62	RLD5-K064	3766 011 001 0	4DM003360-00	61
RLD5-K017	3735 006 001 0	015424819	62	RLD5-K064	3766 011 001 0	4DM004420-04	61
RLD5-K018	3735 016 002 0	3740060-50	62	RLD5-K065	3735 019 001 0	3763040C170	62
RLD5-K019	3735 032 002 0		64	RLD5-K068	3735 021 001 0	960959877	62
RLD5-K020	3735 033 002 0		64	RLD5-K070	3735 023 002 0	0005451324	63
RLD5-K020A	3735 033 001 0	JD2914	64	RLD5-K070	3735 023 002 0	6205400624	63
RLD5-K021	3735 033 002 0		64	RLD5-K071	3766 023 001 0	0005431015	63
RLD5-K021A	3735 033 001 0	JD2912	64	RLD5-K071	3766 023 001 0	0005432815	63
RLD5-K022	3735 035 002 0		64	RLD5-K071	3766 023 001 0	0005439015	63
RLD5-K022A	3735 035 001 0		64	RLD5-K071	3766 023 001 0	0005431915	63
RLD5-K023	3735 036 002 0		65	RLD5-K071	3766 023 001 0	0005432415	63
RLD5-K023A	3735 036 001 0	JD2912	65	RLD5-K071	3766 023 001 0	0005437815	63
RLD5-K024	3735 037 001 0	JD2914	65	RLD5-K072	3722 003 001 0	0005439015	63
RLD5-K025	3766 010 001 0	0035443032	59	RLD5-K073	3722 003 002 0	0005438915	63
RLD5-K025	3766 010 001 0	0035443732	59	RLD5-K074	3735 011 001 0	3735020-C0100	63
RLD5-K025	3766 010 001 0	0035444332	59	RLD5-K075	3766 009 001 0	3735015-C0100	61
RLD5-K025	3766 010 001 0	0035445032	59	RLD5-K076	3735 054 001 0	69200580074	63
RLD5-K025	3766 010 001 0	0035446132	59	RLD5-K077	3735 060 001 0		63
RLD5-K028	3766 012 001 0	EF0312	59	RLD5-K078	3735 059 001 0	37Z63J-35510	63
RLD5-K029	3766 012 002 0	EF0212	59	RLD5-K079	3735 058 001 0	3638010-C0100	64
RLD5-K030	3766 013 001 0	EF0316	59	RLD5-K080	3735 062 001 0		64
RLD5-K031	3766 015 001 0	EF0212H	59	RLD5-K081	3766 055 001 0	36A43D-40021	61
RLD5-K032	3766 015 002 0	EF0312H	59	RLD5-K082	3766 055 002 0	36A43D-40020	61
RLD5-K033	3766 013 002 0	EF0320	59	RLD5-L001	3792 507 002 0	6HF002372051	66
RLD5-K034	3766 014 001 0	EF0216	59	RLD5-L001	3792 507 002 0	0045450224	66
RLD5-K035	3766 014 002 0	EF0220	59	RLD5-L001	3792 507 002 0	81.25503.0130	66
RLD5-K036	3766 016 002 0	EF0312L	59	RLD5-L001	3792 507 002 0	88.25503.0062	66
RLD5-K037	3766 016 001 0	EF0212L	59	RLD5-L001	3792 507 002 0	A0045450224	66
RLD5-K041	3766 032 001 0	JD2912	66	RLD5-L002	3792 501 001 0		66
RLD5-K042	3766 033 001 0	331490001	66	RLD5-L003	3792 501 002 0	0025457124	66
RLD5-K043	3766 034 001 0	066500-0791	60	RLD5-L003	3792 501 001 0	6HF001579011	66
RLD5-K043	3766 034 001 0	81980-22040	60	RLD5-L004	3792 509 001 0	0005459311	66

INDEX BY SORL PART NUMBERS

SORL No.	Drawing No.	Cross Ref.	Page	SORL No.	Drawing No.	Cross Ref.	Page
RLD5-M013	4101 006 001 0	A0015455809	104	RLD5-N017	3702 002 001 0	AER2907AER3002	68
RLD5-M017	3754 601 001 0	3754030A8E	106	RLD5-N018	3702 003 001 0		68
RLD5-M018	4101 037 001 0	JK611	105	RLD5-N033	3702 004 001 0		68
RLD5-M019	4101 038 001 0	70495271	105	RLD5-N038	3702 006 001 0		68
RLD5-M019	4101 038 001 0	81.25520.0087	105	RLD5-P001A	3721 002 008 0		69
RLD5-M019	4101 038 001 0	81.25520.0152	105	RLD5-P002A	3721 001 015 0		69
RLD5-M020	3758 003 001 0	16100720020	106	RLD5-P004	3721 301 003 0	DL32GD	70
RLD5-M021	3757 004 001 0	36A3D-35001	107	RLD5-P004A	3721 301 001 0	DL32L-12	70
RLD5-M022	4101 039 001 0	228600	105	RLD5-P004B	3721 301 002 0	DL32H-12	70
RLD5-M023	4101 040 001 0	0501208141	105	RLD5-P004C	3721 301 007 0	DL32L-24	70
RLD5-M023	4101 040 001 0	0005456909	105	RLD5-P004D	3721 301 004 0	DL32H-24	70
RLD5-M026	3757 003 001 0	228750	106	RLD5-P005	3721 004 001 0	DL124G	69
RLD5-M028	4101 605 001 0	812552001/1E	105	RLD5-P005A	3721 004 002 0		69
RLD5-M028	4101 605 001 0	81.25520-0134	105	RLD5-P008	3721 002 002 0	0025426820	69
RLD5-M028	4101 605 001 0	81.25520-0171	105	RLD5-P008	3721 002 002 0	DL50G	69
RLD5-M028	4101 605 001 0	81200171	105	RLD5-P009	3721 001 002 0	DL125G	69
RLD5-M033	4101 014 001 0		105	RLD5-P012	3721 005 001 0	DL124G	70
RLD5-M037	4101 049 001 0		106	RLD5-P012A	3721 005 003 0		70
RLD5-M041	3757 099 001 0	4410501230	107	RLD5-P013	3798 301 001 0	1341796	70
RLD5-M041	3757 099 001 0	81.25937-0040	107	RLD5-P013	3798 301 001 0	1514259	70
RLD5-M042	3757 099 002 0	4410501000	107	RLD5-P013	3798 301 001 0	1771638	70
RLD5-M043	3813 306 001 0		107	RLD5-P013	3798 301 001 0	1784671	70
RLD5-M044	3757 003 004 0		106	RLD5-P013	3798 301 001 0	1874273	70
RLD5-M045	3757 003 003 0	276599	106	RLD5-P013	3798 301 001 0	1874274	70
RLD5-M046	3802 121 001 0	4410400150	107	RLD5-P013	3798 301 001 0	514259	70
RLD5-M047	3802 122 001 0	4410441080	107	RLD5-P013	3798 301 001 0	65A00078	70
RLD5-M048	3757 001 001 0	RZ28QK	107	RLD5-P014	3721 006 001 0	DL50B	70
RLD5-M050	3757 601 005 0	3757050-435	107	RLD5-P015	3721 007 001 0	805	71
RLD5-M051	4101 028 008 0	3774010-367	108	RLD5-P020	3721 302 001 0	DL34G/D	71
RLD5-M052	4101 019 001 0	3729100-116	108	RLD5-P021	3721 008 001 0	DL34G	71
RLD5-M053	4101 022 001 0	3729100-240	108	RLD5-P028	3798 002 007 0		71
RLD5-M054	4101 023 001 0	3774010-109	108	RLD5-P029	3798 002 006 0		71
RLD5-M055	1608 101 001 0	0015429318	108	RLD5-P030	3798 002 005 0		71
RLD5-N001	3702 001 001 0	0192053006	67	RLD5-P030A	3798 002 009 0		71
RLD5-N001	3702 001 001 0	0192053011	67	RLD5-P034	3798 007 001 0		71
RLD5-N001	3702 001 001 0	0192053013	67	RLD5-P036	3798 008 001 0		71
RLD5-N001	3702 001 001 0	192053005	67	RLD5-P036A	3798 008 002 0		71
RLD5-N003	3702 009 002 0	1197311026	67	RLD5-P037	3798 002 003 0		72
RLD5-N003	3702 009 002 0	1197311027	67	RLD5-P037A	3798 0020190		72
RLD5-N003	3702 009 002 0	1197311028	67	RLD5-P038	3798 002 013 0	WG9100270065	72
RLD5-N003	3702 009 002 0	1197311035	67	RLD5-P039	3798 002 002 0		72
RLD5-N003	3702 009 002 0	1197311038	67	RLD5-P040	3798 002 001 0		72
RLD5-N003	3702 009 002 0	1197311040	67	RLD5-P041	3798 009 001 0		72
RLD5-N003	3702 009 002 0	1197311041	67	RLD5-P042	3798 009 002 0		72
RLD5-N004	3702 010 001 0	1197311213	67	RLD5-P043	3798 010 001 0		72
RLD5-N005	3702 010 003 0	119731232	67	RLD5-P044	3798 002 008 0	26310DB810	72
RLD5-N005	3702 010 003 0	119731234	67	RLD5-P045	3798 001 004 0		72
RLD5-N005	3702 010 003 0	119731239	67	RLD5-P045A	3798 0010050		72
RLD5-N005	3702 010 003 0	119731513	67	RLD5-P046	3798 011 001 0		72
RLD5-N005	3702 010 003 0	119731514	67	RLD5-P047	3798 012 001 0		73
RLD5-N006	3702 011 001 0	1197311021	67	RLD5-P048	3798 013 001 0		73
RLD5-N007	3702 007 001 0	0192052001	67	RLD5-P049	3798 014 001 0		73
RLD5-N007	3702 007 001 0	0192052002	67	RLD5-P050	3798 014 002 0		73
RLD5-N007	3702 007 001 0	0192052090	67	RLD5-P051	3798 001 006 0		73
RLD5-N007	3702 007 001 0	1179311090	67	RLD5-P052	3798 013 002 0		73
RLD5-N007	3702 007 001 0	2197311090	67	RLD5-P053	3798 015 001 0		73
RLD5-N014	3702 014 001 0		67	RLD5-P055	3798 016 001 0		73
RLD5-N015	3702 004 002 0	162.0084	67	RLD5-P056	3798 017 001 0		73
RLD5-N016	3702 002 002 0	0192033003	68	RLD5-P057	3798 006 001 0		73
RLD5-N016	3702 002 002 0	0192033005	68	RLD5-P058	3798 001 002 0	Foom145307	73
RLD5-N017	3702 002 001 0	0192033001,02,04	68	RLD5-P059	3721 009 001 0	DL137G/D	71
RLD5-N017	3702 002 001 0	11635831	68	RLD5-P059A	3721 009 002 0		71
RLD5-N017	3702 002 001 0	11125026	68	RLD5-P060	3754 033 001 0		70
RLD5-N017	3702 002 001 0	11125105	68	RLD5-P061	3721 305 002 0		70

INDEX BY SORL PART NUMBERS

SORL No.	Drawing No.	Cross Ref.	Page	SORL No.	Drawing No.	Cross Ref.	Page
RLD5-P062	3721 305 003 0		70	RLD5-R053	3754 012 037 0	5006305805	79
RLD5-R001	3754 001 001 0		74	RLD5-R053	3754 012 037 0	9472128908	79
RLD5-R002	3754 001 002 0		74	RLD5-R053	3754 012 037 0	E4420001031	79
RLD5-R003	3754 001 007 0	3754010-Q320	74	RLD5-R054	3754 012 051 0	4721717000	79
RLD5-R004	3754 001 015 0	3754010-Q304	74	RLD5-R055	3754 012 048 0	4721717060	79
RLD5-R005	3754 001 006 0	3754030-Q422K	74	RLD5-R056	3754 012 044 0	4721760600	79
RLD5-R006	3754 001 005 0	3754010-Q422	74	RLD5-R057	3754 012 046 0	4721716860	79
RLD5-R007	3754 028 001 0		74	RLD5-R058	3754 012 038 0	4721732260	79
RLD5-R008	3754 001 014 0	3754010K1H(DF252)	74	RLD5-R059	3754 012 047 0	4721727860	80
RLD5-R009	3754 002 006 0	37N-54010	75	RLD5-R061	3754 055 001 0	002472043	80
RLD5-R009	3754 002 006 0	37N-54010(DF251)	75	RLD5-R061	3754 055 001 0	0745582	80
RLD5-R010	3754 002 011 0	3754010A8E-LT(DF251)	75	RLD5-R061	3754 055 001 0	1232316	80
RLD5-R011	3754 002 010 0	3754010A8E	75	RLD5-R061	3754 055 001 0	1591034	80
RLD5-R012	3754 029 001 0	DF254	75	RLD5-R061	3754 055 001 0	24762043	80
RLD5-R013	3754 031 001 0	35AD-49020DF357	75	RLD5-R061	3754 055 001 0	4721271400	80
RLD5-R014	3754 016 001 0	6606Z06-010	75	RLD5-R061	3754 055 001 0	51259020009	80
RLD5-R015	3754 011 001 0	DF261	75	RLD5-R061	3754 055 001 0	532941	80
RLD5-R017	3754 010 001 0	1.79101E+11	75	RLD5-R061	3754 055 001 0	736924	80
RLD5-R018	3754 023 001 0	AZ79100710008	76	RLD5-R061	3754 055 001 0	736925	80
RLD5-R020	3754 021 001 0	3721115-116ADF152A	84	RLD5-R061	3754 055 001 0	81521606020	80
RLD5-R020A	3754 021 003 0		84	RLD5-R061	3754 055 001 0	M0009974036	80
RLD5-R021	3754 032 001 0		84	RLD5-R062	3754 012 020 0	5184310110	80
RLD5-R022	3754 013 001 0	VF-102	76	RLD5-R063	3754 012 021 0	5184310210	80
RLD5-R023	3759 026 001 0	5001844056	76	RLD5-R064	3754 012 022 0	5184310310	80
RLD5-R023	3754 026 001 0	81619670016	76	RLD5-R065	3754 012 023 0	5184310410	80
RLD5-R023	3755 026 001 0	81619676022	76	RLD5-R066	3754 012 024 0	5184310510	80
RLD5-R023	3756 026 001 0	81619670011	76	RLD5-R067	3754 003 015 0	2410100H3J10	81
RLD5-R023	3758 026 001 0	A0018302184	76	RLD5-R068	3754 012 013 0	35AD-14010-4	81
RLD5-R023	3757 026 001 0	A0028302784	76	RLD5-R069	3754 012 014 0	35AD-14010-5	81
RLD5-R025	3754 008 001 0	11271	76	RLD5-R070	3754 012 030 0	52310-Y3B00	81
RLD5-R026	3754 008 002 0	11253	76	RLD5-R071	3754 001 034 0	52310-Y5C0G	81
RLD5-R027	3754 014 001 0		76	RLD5-R072	3754 012 008 0		81
RLD5-R029	3754 035 001 0	H-7B000S	76	RLD5-R073	3754 003 055 0	3549010-E7	81
RLD5-R030A	3754 020 002 0		77	RLD5-R073	3754 003 055 0	3549010-E46	81
RLD5-R030B	3754 020 003 0		77	RLD5-R074	3754 003 052 0	3549010-E8	81
RLD5-R030C	3754 020 004 0		77	RLD5-R075	3754 003 012 0	3754010-369	81
RLD5-R030D	3754 020 005 0		77	RLD5-R075	3754 003 012 0	DF257A	81
RLD5-R031	3754 001 025 0	3611105-79A	77	RLD5-R076	3754 003 046 0	3754030-D598	82
RLD5-R032	3754 003 021 0		77	RLD5-R077	3754 003 050 0	3754010-1K7	82
RLD5-R033	3754 003 014 0		77	RLD5-R078	3754 003 017 0	3751030-0219	82
RLD5-R034	3754 027 001 0		84	RLD5-R079	3754 012 033 0	3754010-0598	82
RLD5-R035	3754 037 001 0		77	RLD5-R080	3754 003 001 0	3754010-240	82
RLD5-R036	3754 004 001 0		77	RLD5-R081	3754 003 002 0	3754020-260	82
RLD5-R037	3754 009 001 0		77	RLD5-R082	3754 003 044 0	3754030-D849	82
RLD5-R038	3754 012 006 0		77	RLD5-R083	3754 003 031 0	35490380018	82
RLD5-R039	3754 003 022 0	3549010-E15	77	RLD5-R084	3754 003 054 0	305035140002	83
RLD5-R040	3754 039 001 0		77	RLD5-R085	3754 003 035 0	35490100118	83
RLD5-R041	3754 040 001 0		78	RLD5-R086	3754 003 038 0	35490100138	83
RLD5-R042	3754 038 001 0	RL3516LAAE4	78	RLD5-R087	3754 001 013 0	3557-10-00005	83
RLD5-R043	3754 012 004 0		78	RLD5-R088	3754 001 017 0	5114340001	83
RLD5-R044	3754 012 009 0		78	RLD5-R089	3754 001 028 0	309035140001	83
RLD5-R048	3754 012 049 0	4720706390	78	RLD5-R090	3754 001 030 0	3557-10-0008	83
RLD5-R049	3754 012 050 0	4720726390	78	RLD5-R091	3754 002 012 0	GFD1090P4K	83
RLD5-R050	3754 012 052 0	11062023	78	RLD5-R092	3754 012 001 0		84
RLD5-R050	3754 012 052 0	1470633	78	RLD5-R093	3754 047 006 0		84
RLD5-R050	3754 012 052 0	41025616	78	RLD5-R096	3754 014 003 0	35490130078	84
RLD5-R050	3754 012 052 0	4721706060	78	RLD5-R097	3754 014 005 0	35490130098	84
RLD5-R050	3754 012 052 0	5010347977	78	RLD5-R098	3754 006 001 0	GM9324822900	84
RLD5-R050	3754 012 052 0	99707005851	78	RLD5-R099	3754 049 002 0	37570421008	84
RLD5-R050	3754 012 052 0	YC444K072AA	78	RLD5-Z001	3711 003 001 0	0005015315	85
RLD5-R051	3754 012 045 0	4721706160	78	RLD5-Z002	3711 004 001 0		85
RLD5-R053	3754 012 037 0	1639096	79	RLD5-Z003	3711 005 001 0	1235010105	85
RLD5-R053	3754 012 037 0	42546462	79	RLD5-Z003	3711 005 001 0	1245000106	85
RLD5-R053	3754 012 037 0	4721710000	79	RLD5-Z003	3711 005 001 0	1245010515	85

INDEX BY SORL PART NUMBERS

SORL No.	Drawing No.	Cross Ref.	Page	SORL No.	Drawing No.	Cross Ref.	Page
RLD5-Z003	3711 005 001 0	1295000006	85	RLD5-Z073	3792 048 001 0	0005459915	88
RLD5-Z003	3711 005 001 0	2025000406	85	RLD5-Z076	4101 622 001 0	0012033975	90
RLD5-Z004	3711 006 001 0	0005016415	85	RLD5-Z076	4101 622 001 0	61673540	90
RLD5-Z004	3711 006 001 0	0000401908	85	RLD5-Z076	4101 622 001 0	022039175	90
RLD5-Z006	3711 007 001 0	1235014615	85	RLD5-Z076	4101 622 001 0	61673540	90
RLD5-Z006	3711 007 001 0	0005017215	85	RLD5-Z076	4101 622 001 0	022039175	90
RLD5-Z009	3711 010 001 0	05080172AA	85	RLD5-Z077	4101 622 002 0	0012033975	90
RLD5-Z009	3711 010 001 0	1020180080	85	RLD5-Z077	4101 622 002 0	0022033275	90
RLD5-Z009	3711 010 001 0	1020180302	85	RLD5-Z077	4101 622 002 0	0022035475	90
RLD5-Z009	3711 010 001 0	1020180380	85	RLD5-Z078	4101 622 003 0		90
RLD5-Z009	3711 010 001 0	1020180402	85	RLD5-Z081	3711 002 001 0		86
RLD5-Z009	3711 010 001 0	1020180802	85	RLD5-Z082	1705 501 001 0	81970106011	90
RLD5-Z009	3711 010 001 0	1110180302	85	RLD5-Z082	1705 501 001 0	585LL	90
RLD5-Z009	3711 010 001 0	0000180702	85	RLD5-Z083	4101 616 001 0		88
RLD5-Z009	3711 010 001 0	3440187002	85	RLD5-Z084	4101 054 001 0	0005456314	89
RLD5-Z012	4101 700 001 0		86	RLD5-Z084	4101 054 001 0	80545491	89
RLD5-Z013	4101 701 001 0		86	RLD5-Z085	3711 012 001 0		86
RLD5-Z014	4101 702 001 0		86	RLD5-Z089	3725 002 001 0	81289010017	89
RLD5-Z014A	4101 702 002 0		86	RLD5-Z089	3725 002 001 0	81289010018	89
RLD5-Z014B	4101 702 003 0		86	RLD5-Z089	3725 002 001 0	81289020004	89
RLD5-Z014C	4101 702 004 0		86	RLD5-Z090	1705 506 001 0		90
RLD5-Z014D	4101 702 005 0		87	RLD5-Z090A	1705 506 002 0	384970	90
RLD5-Z015	4101 703 001 0		87	RLD5-Z090B	1705 506 003 0	1369975	90
RLD5-Z016	4101 704 001 0		87	RLD5-Z090B	1705 506 003 0	384970	90
RLD5-Z017	4101 705 001 0		87	RLD5-Z100	1705 502 002 0	3088-A6913	91
RLD5-Z018	4101 706 001 0	0142064	87	RLD5-Z101	1705 502 001 0	3088-A6915	91
RLD5-Z018	4101 706 001 0	221825009039C	87	RLD5-Z102	1705 501 002 0		91
RLD5-Z018	4101 706 001 0	221825009160C	87	RLD5-Z103	1705 503 002 0		91
RLD5-Z018	4101 706 001 0	0005428117	87	RLD5-Z104	1705 503 001 0	A4487	91
RLD5-Z021	3711 008 001 0		85	RLD5-Z105	4101 617 001 0		89
RLD5-Z033	4101 211 001 0	3136A	87	RLD5-Z106	4101 618 001 0		89
RLD5-Z033	4101 211 001 0	F37A-3N823-AA	87	RLD5-Z109	4101 056 001 0	BE13250	105
RLD5-Z033A	4101 086 001 0		87	RLD5-Z110	1705 502 013 0	A6909	91
RLD5-Z033B	4101 086 002 0		87	RLD5-Z111	1705 502 014 0	A6910	91
RLD5-Z038	3871 005 001 0	01163920	87	RLD5-Z112	1705 508 001 0	20488052	91
RLD5-Z038	3871 005 001 0	276590370	87	RLD5-Z113	1705 509 001 0	1655853	92
RLD5-Z038	3871 005 001 0	397580003	87	RLD5-Z114	1705 507 001 0		91
RLD5-Z038	3871 005 001 0	0005456017	87	RLD5-Z115	3711 002 002 0	1101710-Q407	86
RLD5-Z038	3871 005 001 0	5446209	87	RLD5-Z117A	3709 001 036 8	2025450081	89
RLD5-Z038	3871 005 001 0	5446290	87	RLD5-Z118	1705 510 001 0	4630550500	92
RLD5-Z043	3725 003 001 0	37AD-25010	89	RLD5-Z119	1705 511 001 0	1665981	92
RLD5-Z044	3725 001 001 0	199000580141	89	RLD5-Z120	1705 512 001 0	4630550520	92
RLD5-Z045	4101 024 001 0	286649	87	RLD5-Z120	1705 512 001 0	1665981	92
RLD5-Z047	3709 001 001 0	0005453704	88	RLD5-Z121	1705 513 001 0	20488063	92
RLD5-Z047	3709 001 001 0	0005456704	88	RLD5-Z121	1705 513 001 0	20493844	92
RLD5-Z047	3709 001 001 0	0005454704	88	RLD5-Z122	1705 514 001 0	20488061	92
RLD5-Z047	3709 001 001 0	80933003001	88	RLD5-Z123	1705 515 001 0	20488058	92
RLD5-Z048	3711 009 001 0		85	RLD5-Z124	1705 516 001 0	81326200049	92
RLD5-Z053	3758 006 001 0	0015451815	88	RLD5-Z125	1705 517 001 0	81326200043	92
RLD5-Z053	3758 006 001 0	0025453990	88	RLD5-Z125	1705 517 001 0	81326200039	92
RLD5-Z054	4101 101 001 0	0015450214	88	RLD5-Z125	1705 517 001 0	81326200085	92
RLD5-Z054	4101 101 001 0	0015454914	88	RLD5-Z126	1705 518 001 0	22 260 0045	93
RLD5-Z054	4101 101 001 0	41822394	88	RLD5-Z126	1705 518 001 0	81326200083	93
RLD5-Z054	4101 101 001 0	7311080000	88	RLD5-Z127	1705 519 001 0	81326200095	93
RLD5-Z055	4101 102 001 0	AZ9100589040	88	RLD5-Z128	1705 520 001 0	A4900	93
RLD5-Z065	3725 007 001 0		89	RLD5-Z129	1705 521 001 0	A5010	93
RLD5-Z066	4101 615 001 0	234387	88	RLD5-Z130	1705 522 001 0	1727377	93
RLD5-Z068	1705 504 001 0	6202600040	90	RLD5-Z131	1705 523 001 0	1441235	93
RLD5-Z073	3792 048 001 0	03056	88	RLD5-Z132	1705 524 001 0	A6918	93
RLD5-Z073	3792 048 001 0	0678792	88	RLD5-Z133	1705 525 001 0	174.6933	93
RLD5-Z073	3792 048 001 0	167771	88	RLD5-Z134	1705 526 001 0	174.6934	94
RLD5-Z073	3792 048 001 0	4786024	88	RLD5-Z135	1705 502 032 0	A-6918	94
RLD5-Z073	3792 048 001 0	0005451630	88	RLD5-Z136	1705 528 001 0	A7318	94
RLD5-Z073	3792 048 001 0	0005452319	88	RLD5-Z137	1705 529 001 0	A7315	94

INDEX BY SORL PART NUMBERS

SORL No.	Drawing No.	Cross Ref.	Page					
RLD5-Z138	1705 530 001 0	A7313	94					
RLD5-Z139	1705 531 001 0	7420915349	94					
RLD5-Z140	3802 120 001 0	OK43F55475	103					
RLD5-Z140	3802 120 001 0	OK72A5495A	103					
RLD5-Z141	3802 452 003 0	0125422417	103					
RLD5-Z143	3802 452 004 0	0145424117	103					
RLD5-Z144	3802 601 007 0	0125424717	103					
RLD5-Z145	3802 452 005 0	0265421317	104					
RLD5-Z146	3802 601 008 0	0135426217	104					
RLD5-Z147	3802 123 001 0		104					
	3774 004 012 0	3575400245	1					
	3774 004 013 0	3575400345	1					
	3774 004 014 0	6375400145	1					
	3774 004 015 0	3675400245	1					
	3774 004 016 0	3435400045	1					
	3774 004 017 0	3765400145	1					
	3774 004 018 0	6735400445	1					
	3774 004 019 0	6735400545	1					
	3774 004 020 0	6735400645	1					
	3774 004 021 0	6735400745	1					
	3774 004 022 0	6555400145	1					
	3774 004 023 0	6555400045	1					
	3774 004 024 0	4255400045	1					
	3774 004 025 0	4375400045	1					
	3774 004 026 0	4375400145	1					
	3774 004 027 0	3575400145	1					
	1705 002 003 0	1703020AA9K	95					
	1705 002 004 0	1308617300008	95					
	1705 002 005 0	111281700002	95					
	1705 002 007 0		95					
	1705 002 008 0	1703020-BQ109	95					
	1705 002 009 0		95					
	1705 002 010 0	1703025-739/B	95					
	1705 002 011 0	1703020-BQ802	95					
	1705 002 012 0	G0173020011A0	95					
	1705 502 015 0	G0173020030A0	95					
	1705 502 016 0	G0173020043A0	95					
	1705 502 017 0	G0173020045A0	95					
	1705 502 018 0	G0173020039A0	95					
	1705 502 019 0	1703020-BQ509	95					
	1705 502 020 0	1703020-BQ836	95					
	1705 502 021 0	G0173020051A0	95					
	1705 002 022 0	1703020BJH800	96					
	1705 002 023 0	G0173020060A0	96					
	1705 002 024 0	1703040-D649G	96					
	1705 002 025 0	1073020-810	96					
	1705 002 027 0	1703020-BQ902	96					

